



DATA PROJECTOR

MODEL

XG-C465X

XG-C435X

SETUP MANUAL

Setting up the Screen	2	When Connecting Using Telnet	30
Screen Size and Projection Distance	3	SETUP MENU (Main Menu)	31
Throw Distance	3	ADVANCED SETUP MENU	31
Standard Zoom Lens	4	View Setting Detail List ([V]View All Setting)	32
Wide-zoom Lens (AN-C12MZ)	5	Set Items	32
Tele-zoom Lens (AN-C18MZ)	6	Save Settings and Quit ([S]Save & Quit)	33
Tele-zoom Lens (AN-C27MZ)	7	Quit without Saving Settings ([Q]Quit Unchanged) ..	33
Tele-zoom Lens (AN-C41MZ)	8	IP Address Setting ([1]IP Address)	34
Changing the Lens	9	Subnet Mask Setting ([2]Subnet Mask)	34
Connecting Pin Assignments	11	Default Gateway Setting ([3]Default Gateway)	34
RS-232C Specifications and Commands	13	User Name Setting ([4]User Name)	34
Computer control	13	Password Setting ([5]Password)	35
Communication conditions	13	RS-232C Baud Rate Setting	
Basic format	13	([6]RS-232C Baud Rate)	35
Commands	14	Projector Name Setting ([7]Projector Name)	35
Setting up the Projector Network Environment ...	18	DHCP Client Setting ([8]DHCP Client)	35
Network settings on the computer	18	Disconnecting All Connections	
1. Connecting the Projector to a Computer	19	([D]Disconnect All)	36
2. Setting an IP Address for the Computer	20	Entering ADVANCED SETUP MENU	
3. Setting up a Network Connection for the Projector	22	([A]Advanced Setup)	36
Controlling the Projector via LAN	24	Setting Auto Logout Time	
Controlling the Projector Using Internet Explorer		(ADVANCED[1]Auto Logout Time)	36
(Version 5.0 or later)	24	Data Port Setting (ADVANCED[2]Data Port)	36
Confirming the Projector Status (Status)	25	Carrying out Network Ping Test	
Controlling the Projector (Control)	25	(ADVANCED[5]Network Ping Test)	37
Setting and Adjusting the Projector		Setting of Accept IP Address (ADVANCED[6]Accept	
(Settings & Adjustments)	26	IP Addr(1) – [8]Accept IP Addr(3))	37
Setting the Security (Network – Security)	26	Accepting All IP Addresses	
Making General Settings for the Network		(ADVANCED[9]Accept All IP Addr)	37
(Network - General)	27	Setting of Search Port	
Setting for Sending E-mail when an Error Occurs		(ADVANCED[0]Search Port)	38
(Mail – Originator Settings)	27	Return to Default Settings	
Setting Error Items and Destination Addresses		(ADVANCED[!]Restore Default Setting)	38
to which E-mail is to be Sent when an		Return to Main Menu	
Error Occurs (Mail – Recipient Settings) ...	28	(ADVANCED[Q]Return to Main Menu)	38
Setting Error Items and the URL that are to be		Resetting the Lamp Timer of the Projector	
Displayed when an Error Occurs		via LAN	39
(Service & Support – Access URL)	28	Troubleshooting	41
Setting up the Projector Using RS-232C or Telnet	29	Dimensions	44
When Connecting Using RS-232C	29		

Setting up the Screen

For optimal image quality, position the projector perpendicular to the screen with the projector's feet flat and level. Doing so will eliminate the need for Keystone correction and provide the best image quality.

Note

- The projector lens should be centered in the middle of the screen. If the horizontal line passing through the lens center is not perpendicular to the screen, the image will be distorted, making viewing difficult.
- For an optimal image, position the screen so that it is not in direct sunlight or room light. Light falling directly on the screen washes out the colors, making viewing difficult. Close the curtains and dim the lights when setting up the screen in a sunny or bright room.

Standard Setup (Front Projection)

- Place the projector at the required distance from the screen according to the desired picture size.

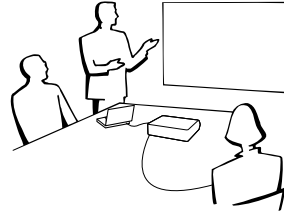

Example of standard setup

Side View

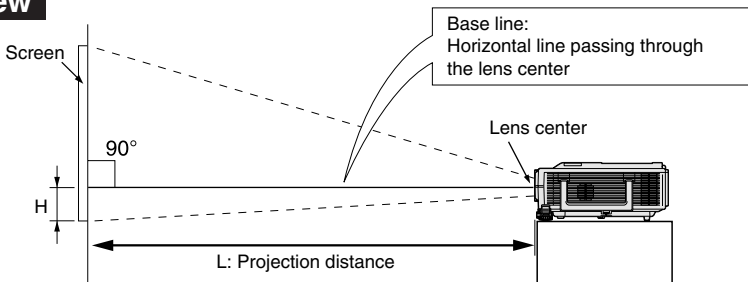

- The distance from the screen to the projector may vary depending on the size of the screen.
- The default setting can be used, when placing the projector in front of the screen. If the projected image is reversed, readjust the setting to “Front” in the “PRJ Mode” menu. (See page 52 of the projector’s operation manual.)
- Place the projector so that an imaginary horizontal line that passes through the center of the lens is perpendicular to the screen.

Screen Size and Projection Distance

The projection screen size varies according to the distance from the lens of the projector to the screen. The optional lenses from Sharp are also available for specialized application. Please see your nearest Sharp Authorized Projector Dealer to details on all the lenses. (Refer to the lens operation manual when using a lens.)

Install the projector so that projected images are projected onto the screen at the optimum size by referring to the table. Use the values in the table as a reference when installing the projector.

Throw Distance

The graph below is for 100 inches (254 cm) screen with 4:3 normal mode.

Screen

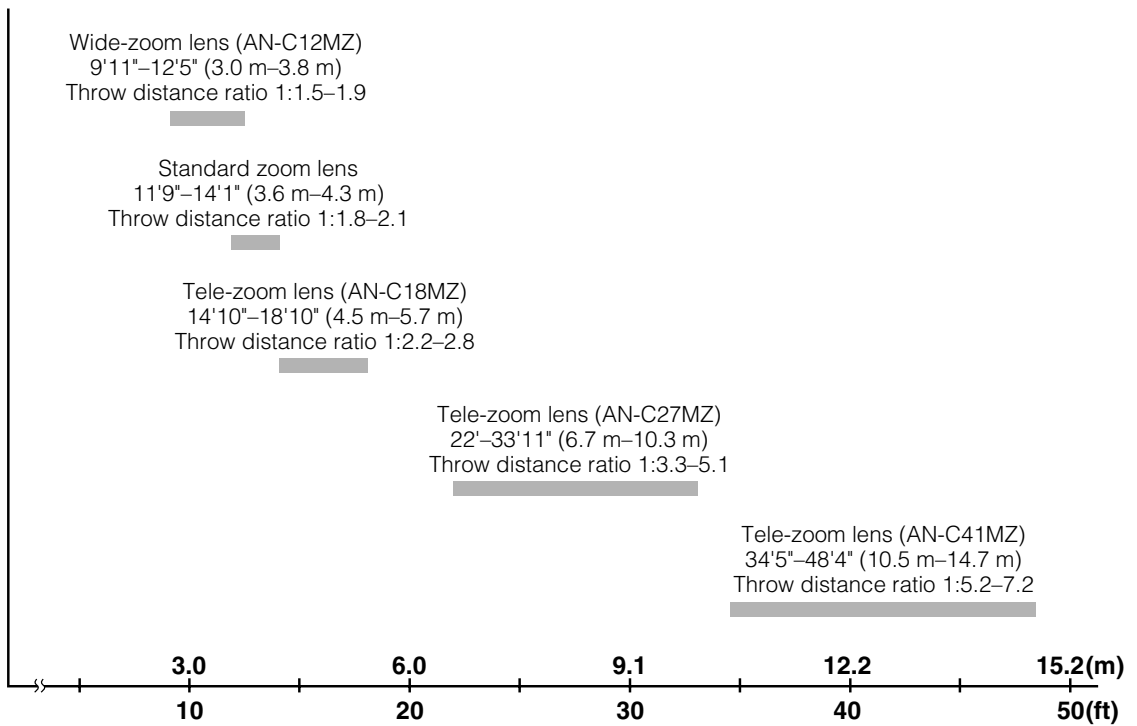

Screen Size and Projection Distance

Standard Zoom Lens

F1.7-F1.9, f=28.0-33.6 mm

NORMAL Mode (4:3)

Picture (Screen) size			Projection distance [L]		Distance from the lens center to the bottom of the image [H]
Diag. [χ]	Width	Height	Minimum [L1]	Maximum [L2]	
500" (1270 cm)	1016 cm (400")	762 cm (300")	17.9 m (58' 7")	21.4 m (70' 4")	-76 cm (-30")
300" (762 cm)	610 cm (240")	457 cm (180")	10.7 m (35' 2")	12.9 m (42' 2")	-46 cm (-18")
270" (686 cm)	549 cm (216")	411 cm (162")	9.6 m (31' 8")	11.6 m (38')	-41 cm (-16 13/64")
250" (635 cm)	508 cm (200")	381 cm (150")	8.9 m (29' 3")	10.7 m (35' 2")	-38 cm (-15")
200" (508 cm)	406 cm (160")	305 cm (120")	7.1 m (23' 5")	8.6 m (28' 1")	-30 cm (-12")
150" (381 cm)	305 cm (120")	229 cm (90")	5.4 m (17' 7")	6.4 m (21' 1")	-23 cm (-9")
100" (254 cm)	203 cm (80")	152 cm (60")	3.6 m (11' 9")	4.3 m (14' 1")	-15 cm (-6")
84" (213 cm)	171 cm (67")	128 cm (50")	3.0 m (9' 10")	3.6 m (11' 10")	-13 cm (-5 3/64")
80" (203 cm)	163 cm (64")	122 cm (48")	2.9 m (9' 4")	3.4 m (11' 3")	-12 cm (-4 51/64")
72" (183 cm)	146 cm (58")	110 cm (43")	2.6 m (8' 5")	3.1 m (10' 1")	-11 cm (-4 5/16")
60" (152 cm)	122 cm (48")	91 cm (36")	2.1 m (7')	2.6 m (8' 5")	-9 cm (-3 19/32")
40" (102 cm)	81 cm (32")	61 cm (24")	1.4 m (4' 8")	1.7 m (5' 7")	-6 cm (-2 13/32")

χ: Picture size (diag.) (in/cm)
 L: Projection distance(m/ft)
 L1: Minimum projection distance (m/ft)
 L2: Maximum projection distance (m/ft)
 H: Distance from the lens center to the bottom of the image (cm/in)

The formula for picture size and projection distance
[m/cm]
 L1 (m) = 0.03571χ / 0.3048
 L2 (m) = 0.04286χ / 0.3048
 H (cm) = -0.1524χ
[Feet/inches]
 L1 (ft) = 0.03571χ / 0.3048
 L2 (ft) = 0.04286χ / 0.3048
 H (in) = -0.1524χ / 2.54

STRETCH Mode (16:9)

Picture (Screen) size			Projection distance [L]		Distance from the lens center to the bottom of the image [H]	Adjustable range of image position [S]
Diag. [χ]	Width	Height	Minimum [L1]	Maximum [L2]		
450" (1143 cm)	996 cm (392")	560 cm (221")	17.5 m (57' 5")	21.0 m (68' 11")	19 cm (7 23/64")	±93 cm (±36 49/64")
300" (762 cm)	664 cm (261")	374 cm (147")	11.7 m (38' 3")	14.0 m (45' 11")	12 cm (4 29/32")	±62 cm (±24 33/64")
250" (635 cm)	553 cm (218")	311 cm (123")	9.7 m (31' 11")	11.7 m (38' 4")	10 cm (4 5/64")	±52 cm (±20 27/64")
225" (572 cm)	498 cm (196")	280 cm (110")	8.8 m (28' 9")	10.5 m (34' 6")	9 cm (3 43/64")	±47 cm (±18 25/64")
200" (508 cm)	443 cm (174")	249 cm (98")	7.8 m (25' 6")	9.3 m (30' 8")	8 cm (3 17/64")	±42 cm (±16 11/32")
150" (381 cm)	332 cm (131")	187 cm (74")	5.8 m (19' 2")	7.0 m (23')	6 cm (2 29/64")	±31 cm (±12 1/4")
133" (338 cm)	294 cm (116")	166 cm (65")	5.2 m (17')	6.2 m (20' 4")	6 cm (2 11/64")	±28 cm (±10 7/8")
106" (269 cm)	235 cm (92")	132 cm (52")	4.1 m (13' 6")	4.9 m (16' 3")	4 cm (1 47/64")	±22 cm (±8 21/32")
100" (254 cm)	221 cm (87")	125 cm (49")	3.9 m (12' 9")	4.7 m (15' 4")	4 cm (1 41/64")	±21 cm (±8 11/64")
92" (234 cm)	204 cm (80")	115 cm (45")	3.6 m (11' 9")	4.3 m (14' 1")	4 cm (1 1/2")	±19 cm (±7 33/64")
84" (213 cm)	186 cm (73")	105 cm (41")	3.3 m (10' 9")	3.9 m (12' 10")	3 cm (1 3/8")	±17 cm (±6 59/64")
80" (203 cm)	177 cm (70")	100 cm (39")	3.1 m (10' 3")	3.7 m (12' 3")	3 cm (1 5/16")	±17 cm (±6 17/32")
72" (183 cm)	159 cm (63")	90 cm (35")	2.8 m (9' 2")	3.4 m (11')	3 cm (1 11/64")	±15 cm (±5 57/64")
60" (152 cm)	133 cm (52")	75 cm (29")	2.3 m (7' 8")	2.8 m (9' 2")	2 cm (63/64")	±12 cm (±4 29/32")
40" (102 cm)	89 cm (35")	50 cm (20")	1.6 m (5' 1")	1.9 m (6' 2")	2 cm (21/32")	±8 cm (±3 17/64")

χ: Picture size (diag.) (in/cm)
 L: Projection distance(m/ft)
 L1: Minimum projection distance (m/ft)
 L2: Maximum projection distance (m/ft)
 H: Distance from the lens center to the bottom of the image (cm/in)
 S: Adjustable range of image position (cm/in)

The formula for picture size and projection distance
[m/cm]
 L1 (m) = 0.0389χ
 L2 (m) = 0.04669χ
 H (cm) = 0.04151χ
 S (cm) = ±0.20754χ
[Feet/inches]
 L1 (ft) = 0.0389χ / 0.3048
 L2 (ft) = 0.04669χ / 0.3048
 H (in) = 0.04151χ / 2.54
 S (in) = ±0.20754χ / 2.54



Note

- Allow a margin of error in the value in the diagrams above.
- When the distance from the lens center to the bottom of the image [H] is a negative number, this indicates that the bottom of the image is below the lens center.

Wide-zoom Lens (AN-C12MZ)

F2.2-F2.7, f=24.5-30.7 mm

NORMAL Mode (4:3)

Picture (Screen) size			Projection distance [L]		Distance from the lens center to the bottom of the image [H]	
Diag. [X]	Width	Height	Minimum [L1]	Maximum [L2]		
250" (635 cm)	508 cm (200")	381 cm (150")	7.5 m (24' 9")	9.5 m (31')	-38 cm (-15")	
200" (508 cm)	406 cm (160")	305 cm (120")	6.0 m (19' 10")	7.6 m (24' 10")	-30 cm (-12")	
150" (381 cm)	305 cm (120")	229 cm (90")	4.5 m (14' 10")	5.7 m (18' 7")	-23 cm (-9")	
100" (254 cm)	203 cm (80")	152 cm (60")	3.0 m (9' 11")	3.8 m (12' 5")	-15 cm (-6")	
84" (213 cm)	171 cm (67")	128 cm (50")	2.5 m (8' 4")	3.2 m (10' 5")	-13 cm (-5 3/64")	
80" (203 cm)	163 cm (64")	122 cm (48")	2.4 m (7' 11")	3.0 m (9' 11")	-12 cm (-4 51/64")	
72" (183 cm)	146 cm (58")	110 cm (43")	2.2 m (7' 2")	2.7 m (8' 11")	-11 cm (-4 5/16")	
60" (152 cm)	122 cm (48")	91 cm (36")	1.8 m (5' 11")	2.3 m (7' 5")	-9 cm (-3 19/32")	
40" (102 cm)	81 cm (32")	61 cm (24")	1.2 m (4')	1.5 m (5')	-6 cm (-2 13/32")	

X: Picture size (diag.) (in/cm)
 L: Projection distance(m/ft)
 L1: Minimum projection distance (m/ft)
 L2: Maximum projection distance (m/ft)
 H: Distance from the lens center to the bottom of the image (cm/in)

The formula for picture size and projection distance
[m/cm]
 L1 (m) = 0.03019X
 L2 (m) = 0.03783X
 H (cm) = -0.1524X
[Feet/inches]
 L1 (ft) = 0.03019X / 0.3048
 L2 (ft) = 0.03783X / 0.3048
 H (in) = -0.1524X / 2.54

STRETCH Mode (16:9)

Picture (Screen) size			Projection distance [L]		Distance from the lens center to the bottom of the image [H]		Adjustable range of image position [S]
Diag. [X]	Width	Height	Minimum [L1]	Maximum [L2]			
225" (572 cm)	498 cm (196")	280 cm (110")	7.4 m (24' 3")	9.3 m (30' 5")	9 cm (3 43/64")		±47 cm (±18 25/64")
200" (508 cm)	443 cm (174")	249 cm (98")	6.6 m (21' 7")	8.2 m (27')	8 cm (3 17/64")		±42 cm (±16 11/32")
150" (381 cm)	332 cm (131")	187 cm (74")	4.9 m (16' 2")	6.2 m (20' 3")	6 cm (2 29/64")		±31 cm (±12 1/4")
133" (338 cm)	294 cm (116")	166 cm (65")	4.4 m (14' 4")	5.5 m (18')	6 cm (2 11/64")		±28 cm (±10 7/8")
106" (269 cm)	235 cm (92")	132 cm (52")	3.5 m (11' 5")	4.4 m (14' 4")	4 cm (1 47/64")		±22 cm (±8 21/32")
100" (254 cm)	221 cm (87")	125 cm (49")	3.3 m (10' 9")	4.1 m (13' 6")	4 cm (1 41/64")		±21 cm (±8 11/64")
92" (234 cm)	204 cm (80")	115 cm (45")	3.0 m (9' 11")	3.8 m (12' 5")	4 cm (1 1/2")		±19 cm (±7 33/64")
84" (213 cm)	186 cm (73")	105 cm (41")	2.8 m (9' 1")	3.5 m (11' 4")	3 cm (1 3/8")		±17 cm (±6 55/64")
80" (203 cm)	177 cm (70")	100 cm (39")	2.6 m (8' 8")	3.3 m (10' 10")	3 cm (1 5/16")		±17 cm (±6 17/32")
72" (183 cm)	159 cm (63")	90 cm (35")	2.4 m (7' 9")	3.0 m (9' 9")	3 cm (1 11/64")		±15 cm (±5 57/64")
60" (152 cm)	133 cm (52")	75 cm (29")	2.0 m (6' 6")	2.5 m (8' 1")	2 cm (63/64")		±12 cm (±4 29/32")
40" (102 cm)	89 cm (35")	50 cm (20")	1.3 m (4' 4")	1.6 m (5' 5")	2 cm (21/32")		±8 cm (±3 17/64")

X: Picture size (diag.) (in/cm)
 L: Projection distance(m/ft)
 L1: Minimum projection distance (m/ft)
 L2: Maximum projection distance (m/ft)
 H: Distance from the lens center to the bottom of the image (cm/in)
 S: Adjustable range of image position (cm/in)

The formula for picture size and projection distance
[m/cm]
 L1 (m) = 0.03289X
 L2 (m) = 0.04121X
 H (cm) = 0.04151X
 S (cm) = ±0.20754X
[Feet/inches]
 L1 (ft) = 0.03289X / 0.3048
 L2 (ft) = 0.04121X / 0.3048
 H (in) = 0.04151X / 2.54
 S (in) = ±0.20754X / 2.54



Note

- Allow a margin of error in the value in the diagrams above.
- When the distance from the lens center to the bottom of the image [H] is a negative number, this indicates that the bottom of the image is below the lens center.

Screen Size and Projection Distance

Tele-zoom Lens (AN-C18MZ)

F1.7-F2.2, f=36.5-46.3 mm

NORMAL Mode (4:3)

Picture (Screen) size			Projection distance [L]		Distance from the lens center to the bottom of the image [H]
Diag. [X]	Width	Height	Minimum [L1]	Maximum [L2]	
250" (635 cm)	508 cm (200")	381 cm (150")	11.3 m (37' 2")	14.4 m (47' 1")	-38 cm (-15")
200" (508 cm)	406 cm (160")	305 cm (120")	9.1 m (29' 9")	11.5 m (37' 8")	-30 cm (-12")
150" (381 cm)	305 cm (120")	229 cm (90")	6.8 m (22' 3")	8.6 m (28' 3")	-23 cm (-9")
100" (254 cm)	203 cm (80")	152 cm (60")	4.5 m (14' 10")	5.7 m (18' 10")	-15 cm (-6")
84" (213 cm)	171 cm (67")	128 cm (50")	3.8 m (12' 6")	4.8 m (15' 10")	-13 cm (-5 3/64")
80" (203 cm)	163 cm (64")	122 cm (48")	3.6 m (11' 11")	4.6 m (15' 1")	-12 cm (-4 51/64")
72" (183 cm)	146 cm (58")	110 cm (43")	3.3 m (10' 8")	4.1 m (13' 7")	-11 cm (-4 5/16")
60" (152 cm)	122 cm (48")	91 cm (36")	2.7 m (8' 11")	3.4 m (11' 4")	-9 cm (-3 19/32")
40" (102 cm)	81 cm (32")	61 cm (24")	1.8 m (5' 11")	2.3 m (7' 6")	-6 cm (-2 13/32")

X: Picture size (diag.) (in/cm)
 L: Projection distance(m/ft)
 L1: Minimum projection distance (m/ft)
 L2: Maximum projection distance (m/ft)
 H: Distance from the lens center to the bottom of the image (cm/in)

The formula for picture size and projection distance

[m/cm]
 L1 (m) = 0.04529X
 L2 (m) = 0.05745X
 H1 (cm) = -0.1524X
[Feet/inches]
 L1 (ft) = 0.04529X / 0.3048
 L2 (ft) = 0.05745X / 0.3048
 H (in) = -0.1524X / 2.54

STRETCH Mode (16:9)

Picture (Screen) size			Projection distance [L]		Distance from the lens center to the bottom of the image [H]	Adjustable range of image position [S]
Diag. [X]	Width	Height	Minimum [L1]	Maximum [L2]		
225" (572 cm)	498 cm (196")	280 cm (110")	11.1 m (36' 5")	14.1 m (46' 2")	9 cm (3 43/64")	±47 cm (±18 25/64")
200" (508 cm)	443 cm (174")	249 cm (98")	9.9 m (32' 5")	12.5 m (41' 1")	8 cm (3 17/64")	±42 cm (±16 11/32")
150" (381 cm)	332 cm (131")	187 cm (74")	7.4 m (24' 3")	9.4 m (30' 10")	6 cm (2 29/64")	±31 cm (±12 1/4")
133" (338 cm)	294 cm (116")	166 cm (65")	6.6 m (21' 6")	8.3 m (27' 4")	6 cm (2 11/64")	±28 cm (±10 7/8")
106" (269 cm)	235 cm (92")	132 cm (52")	5.2 m (17' 2")	6.6 m (21' 9")	4 cm (1 47/64")	±22 cm (±8 21/32")
100" (254 cm)	221 cm (87")	125 cm (49")	4.9 m (16' 2")	6.3 m (20' 6")	4 cm (1 41/64")	±21 cm (±8 11/64")
92" (234 cm)	204 cm (80")	115 cm (45")	4.5 m (14' 11")	5.8 m (18' 11")	4 cm (1 1/2")	±19 cm (±7 33/64")
84" (213 cm)	186 cm (73")	105 cm (41")	4.1 m (13' 7")	5.3 m (17' 3")	3 cm (1 3/8")	±17 cm (±6 55/64")
80" (203 cm)	177 cm (70")	100 cm (39")	3.9 m (12' 11")	5.0 m (16' 5")	3 cm (1 5/16")	±17 cm (±6 17/32")
72" (183 cm)	159 cm (63")	90 cm (35")	3.6 m (11' 8")	4.5 m (14' 9")	3 cm (1 11/64")	±15 cm (±5 57/64")
60" (152 cm)	133 cm (52")	75 cm (29")	3.0 m (9' 9")	3.8 m (12' 4")	2 cm (63/64")	±12 cm (±4 29/32")
40" (102 cm)	89 cm (35")	50 cm (20")	2.0 m (6' 6")	2.5 m (8' 3")	2 cm (21/32")	±8 cm (±3 17/64")

X: Picture size (diag.) (in/cm)
 L: Projection distance(m/ft)
 L1: Minimum projection distance (m/ft)
 L2: Maximum projection distance (m/ft)
 H: Distance from the lens center to the bottom of the image (cm/in)
 S: Adjustable range of image position (cm/in)

The formula for picture size and projection distance

[m/cm]
 L1 (m) = 0.04934X
 L2 (m) = 0.06259X
 H (cm) = 0.04151X
 S (cm) = ±0.20754X
[Feet/inches]
 L1 (ft) = 0.04934X / 0.3048
 L2 (ft) = 0.06259X / 0.3048
 H1 (in) = 0.04151X / 2.54
 S (in) = ±0.20754X / 2.54



Note

- Allow a margin of error in the value in the diagrams above.
- When the distance from the lens center to the bottom of the image [H] is a negative number, this indicates that the bottom of the image is below the lens center.

Tele-zoom Lens (AN-C27MZ)

F2.0-F2.8, f=53.8-82.9 mm

NORMAL Mode (4:3)

Picture (Screen) size			Projection distance [L]		Distance from the lens center to the bottom of the image [H]	
Diag. [X]	Width	Height	Minimum [L1]	Maximum [L2]		
250" (635 cm)	508 cm (200")	381 cm (150")	16.8 m (55')	25.9 m (84' 11")	-38 cm (-15")	
200" (508 cm)	406 cm (160")	305 cm (120")	13.4 m (44')	20.7 m (67' 11")	-30 cm (-12")	
150" (381 cm)	305 cm (120")	229 cm (90")	10.1 m (33')	15.5 m (50' 11")	-23 cm (-9")	
100" (254 cm)	203 cm (80")	152 cm (60")	6.7 m (22')	10.3 m (33' 11")	-15 cm (-6")	
84" (213 cm)	171 cm (67")	128 cm (50")	5.6 m (18' 6")	8.7 m (28' 6")	-13 cm (-5 3/64")	
80" (203 cm)	163 cm (64")	122 cm (48")	5.4 m (17' 7")	8.3 m (27' 2")	-12 cm (-4 51/64")	
72" (183 cm)	146 cm (58")	110 cm (43")	4.8 m (15' 10")	7.5 m (24' 5")	-11 cm (-4 5/16")	
60" (152 cm)	122 cm (48")	91 cm (36")	4.0 m (13' 3")	6.2 m (20' 4")	-9 cm (-3 19/32")	
40" (102 cm)	81 cm (32")	61 cm (24")	2.7 m (8' 10")	4.1 m (13' 7")	-6 cm (-2 13/32")	

X: Picture size (diag.) (in/cm)
 L: Projection distance(m/ft)
 L1: Minimum projection distance (m/ft)
 L2: Maximum projection distance (m/ft)
 H: Distance from the lens center to the bottom of the image (cm/in)

The formula for picture size and projection distance
[m/cm]
 L1 (m) = 0.0671X
 L2 (m) = 0.10348X
 H (cm) = -0.1524X
[Feet/inches]
 L1 (ft) = 0.0671X / 0.3048
 L2 (ft) = 0.10348X / 0.3048
 H (in) = -0.1524X / 2.54

STRETCH Mode (16:9)

Picture (Screen) size			Projection distance [L]		Distance from the lens center to the bottom of the image [H]		Adjustable range of image position [S]
Diag. [X]	Width	Height	Minimum [L1]	Maximum [L2]			
225" (572 cm)	498 cm (196")	280 cm (110")	16.4 m (54')	25.4 m (83' 3")	9 cm (3 43/64")	±47 cm (±18 25/64")	
200" (508 cm)	443 cm (174")	249 cm (98")	14.6 m (48')	22.5 m (74')	8 cm (3 17/64")	±42 cm (±16 11/32")	
150" (381 cm)	332 cm (131")	187 cm (74")	11.0 m (36')	16.9 m (55' 6")	6 cm (2 29/64")	±31 cm (±12 1/4")	
133" (338 cm)	294 cm (116")	166 cm (65")	9.7 m (31' 11")	15.0 m (49' 2")	6 cm (2 11/64")	±28 cm (±10 7/8")	
106" (269 cm)	235 cm (92")	132 cm (52")	7.7 m (25' 5")	12.0 m (39' 2")	4 cm (1 47/64")	±22 cm (±8 21/32")	
100" (254 cm)	221 cm (87")	125 cm (49")	7.3 m (24')	11.3 m (37')	4 cm (1 41/64")	±21 cm (±8 11/64")	
92" (234 cm)	204 cm (80")	115 cm (45")	6.7 m (22' 1")	10.4 m (34')	4 cm (1 1/2")	±19 cm (±7 33/64")	
84" (213 cm)	186 cm (73")	105 cm (41")	6.1 m (20' 2")	9.5 m (31' 1")	3 cm (1 3/8")	±17 cm (±6 55/64")	
80" (203 cm)	177 cm (70")	100 cm (39")	5.8 m (19' 2")	9.0 m (29' 7")	3 cm (1 5/16")	±17 cm (±6 17/32")	
72" (183 cm)	159 cm (63")	90 cm (35")	5.3 m (17' 3")	8.1 m (26' 8")	3 cm (1 11/64")	±15 cm (±5 57/64")	
60" (152 cm)	133 cm (52")	75 cm (29")	4.4 m (14' 5")	6.8 m (22' 2")	2 cm (63/64")	±12 cm (±4 29/32")	
40" (102 cm)	89 cm (35")	50 cm (20")	2.9 m (9' 7")	4.5 m (14' 10")	2 cm (21/32")	±8 cm (±3 17/64")	

X: Picture size (diag.) (in/cm)
 L: Projection distance(m/ft)
 L1: Minimum projection distance (m/ft)
 L2: Maximum projection distance (m/ft)
 H: Distance from the lens center to the bottom of the image (cm/in)
 S: Adjustable range of image position (cm/in)

The formula for picture size and projection distance
[m/cm]
 L1 (m) = 0.0731X
 L2 (m) = 0.11274X
 H (cm) = 0.04151X
 S (cm) = ±0.20754X
[Feet/inches]
 L1 (ft) = 0.0731X / 0.3048
 L2 (ft) = 0.11274X / 0.3048
 H (in) = 0.04151X / 2.54
 S (in) = ±0.20754X / 2.54



Note

- Allow a margin of error in the value in the diagrams above.
- When the distance from the lens center to the bottom of the image [H] is a negative number, this indicates that the bottom of the image is below the lens center.

Screen Size and Projection Distance

Tele-zoom Lens (AN-C41MZ)

F2.1-F2.8, f=83.5-117.2 mm

NORMAL Mode (4:3)

Diag. [χ]	Picture (Screen) size		Projection distance [L]		Distance from the lens center to the bottom of the image [H]
	Width	Height	Minimum [L1]	Maximum [L2]	
250" (635 cm)	508 cm (200")	381 cm (150")	26.2 m (86')	36.8 m (120' 9")	-38 cm (-15")
200" (508 cm)	406 cm (160")	305 cm (120")	21.0 m (68' 10")	29.5 m (96' 7")	-30 cm (-12")
150" (381 cm)	305 cm (120")	229 cm (90")	15.7 m (51' 7")	22.1 m (72' 6")	-23 cm (-9")
100" (254 cm)	203 cm (80")	152 cm (60")	10.5 m (34' 5")	14.7 m (48' 4")	-15 cm (-6")
84" (213 cm)	171 cm (67")	128 cm (50")	8.8 m (28' 11")	12.4 m (40' 7")	-13 cm (-5 3/64")
80" (203 cm)	163 cm (64")	122 cm (48")	8.4 m (27' 6")	11.8 m (38' 8")	-12 cm (-4 51/64")
72" (183 cm)	146 cm (58")	110 cm (43")	7.5 m (24' 9")	10.6 m (34' 9")	-11 cm (-4 5/16")
60" (152 cm)	122 cm (48")	91 cm (36")	6.3 m (20' 8")	8.8 m (29')	-9 cm (-3 19/32")
40" (102 cm)	81 cm (32")	61 cm (24")	4.2 m (13' 9")	5.9 m (19' 4")	-6 cm (-2 13/32")

χ: Picture size (diag.) (in/cm)
 L: Projection distance(m/ft)
 L1: Minimum projection distance (m/ft)
 L2: Maximum projection distance (m/ft)
 H: Distance from the lens center to the bottom of the image (cm/in)

The formula for picture size and projection distance

[m/cm]
 L1 (m) = 0.10484χ
 L2 (m) = 0.14725χ
 H (cm) = -0.1524χ
[Feet/inches]
 L1 (ft) = 0.10484χ / 0.3048
 L2 (ft) = 0.14725χ / 0.3048
 H (in) = -0.1524χ / 2.54

STRETCH Mode (16:9)

Diag. [χ]	Picture (Screen) size		Projection distance [L]		Distance from the lens center to the bottom of the image [H]	Adjustable range of image position [S]
	Width	Height	Minimum [L1]	Maximum [L2]		
225" (572 cm)	498 cm (196")	280 cm (110")	25.7 m (84' 4")	36.1 m (118' 5")	9 cm (3 43/64")	±47 cm (±18 25/64")
200" (508 cm)	443 cm (174")	249 cm (98")	22.8 m (74' 11")	32.1 m (105' 3")	8 cm (3 17/64")	±42 cm (±16 11/32")
150" (381 cm)	332 cm (131")	187 cm (74")	17.1 m (56' 3")	24.1 m (78' 11")	6 cm (2 29/64")	±31 cm (±12 1/4")
133" (338 cm)	294 cm (116")	166 cm (65")	15.2 m (49' 10")	21.3 m (70')	6 cm (2 11/64")	±28 cm (±10 7/8")
106" (269 cm)	235 cm (92")	132 cm (52")	12.1 m (39' 9")	17.0 m (55' 9")	4 cm (1 47/64")	±22 cm (±8 21/32")
100" (254 cm)	221 cm (87")	125 cm (49")	11.4 m (37' 6")	16.0 m (52' 8")	4 cm (1 41/64")	±21 cm (±8 11/64")
92" (234 cm)	204 cm (80")	115 cm (45")	10.5 m (34' 6")	14.8 m (48' 5")	4 cm (1 1/2")	±19 cm (±7 33/64")
84" (213 cm)	186 cm (73")	105 cm (41")	9.6 m (31' 6")	13.5 m (44' 3")	3 cm (1 3/8")	±17 cm (±6 55/64")
80" (203 cm)	177 cm (70")	100 cm (39")	9.1 m (30')	12.8 m (42' 1")	3 cm (1 5/16")	±17 cm (±6 17/32")
72" (183 cm)	159 cm (63")	90 cm (35")	8.2 m (27')	11.6 m (37' 11")	3 cm (1 11/64")	±15 cm (±5 57/64")
60" (152 cm)	133 cm (52")	75 cm (29")	6.9 m (22' 6")	9.6 m (31' 7")	2 cm (63/64")	±12 cm (±4 29/32")
40" (102 cm)	89 cm (35")	50 cm (20")	4.6 m (15')	6.4 m (21' 1")	2 cm (21/32")	±8 cm (±3 17/64")

χ: Picture size (diag.) (in/cm)
 L: Projection distance(m/ft)
 L1: Minimum projection distance (m/ft)
 L2: Maximum projection distance (m/ft)
 H: Distance from the lens center to the bottom of the image (cm/in)
 S: Adjustable range of image position (cm/in)

The formula for picture size and projection distance

[m/cm]
 L1 (m) = 0.11422χ
 L2 (m) = 0.16042χ
 H (cm) = 0.04151χ
 S (cm) = ±0.20754χ
[Feet/inches]
 L1 (ft) = 0.11422χ / 0.3048
 L2 (ft) = 0.16042χ / 0.3048
 H (in) = 0.04151χ / 2.54
 S (in) = ±0.20754χ / 2.54



- Allow a margin of error in the value in the diagrams above.
- When the distance from the lens center to the bottom of the image [H] is a negative number, this indicates that the bottom of the image is below the lens center.

Changing the Lens

Info

- Before changing the lens, turn off the power of the projector and remove the power cord from the wall outlet.
- Do not attempt to change the lens while the projector is mounted on the ceiling.

1 Remove the lens housing cover by using the supplied lens housing cover removal tool to push down on the groove on the lens housing cover.

- Hold down the lens housing cover with your hand to prevent it from flying out.

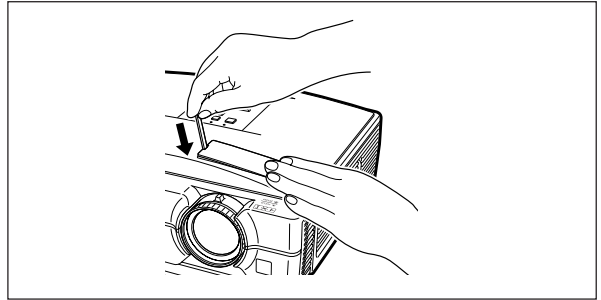

2 Slide the lens fastener catch tab in the direction of “UNLOCK” while holding the lens to prevent it from falling out.

- Slide the lens fastener catch tab until the window located beside “LOCK” comes to the top. Look inside the window to make sure that the two grooves on the lens fastener ring are facing up.

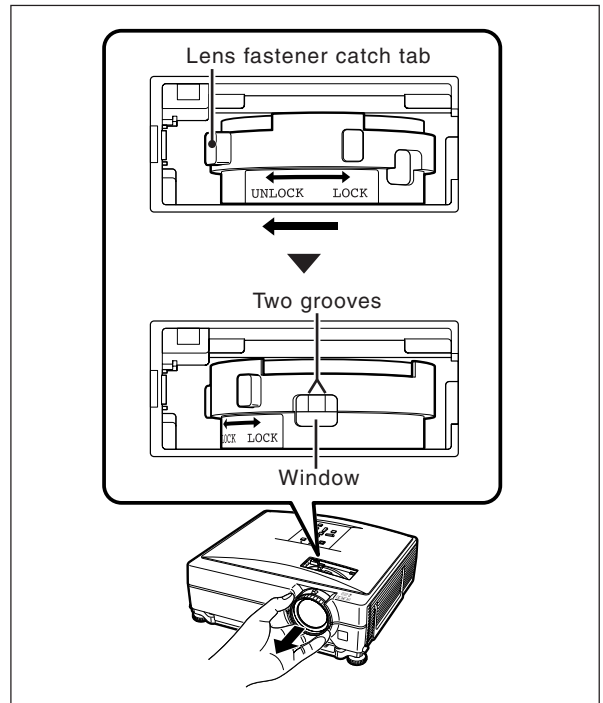

3 Remove the lens by pulling it straight out.

4 Remove the protection cap from the back of the new lens.

Changing the Lens

5 Insert the lens into the projector.

- As you insert the lens, look inside the window to make sure that the pin is inserted into the hole of the lens mount.

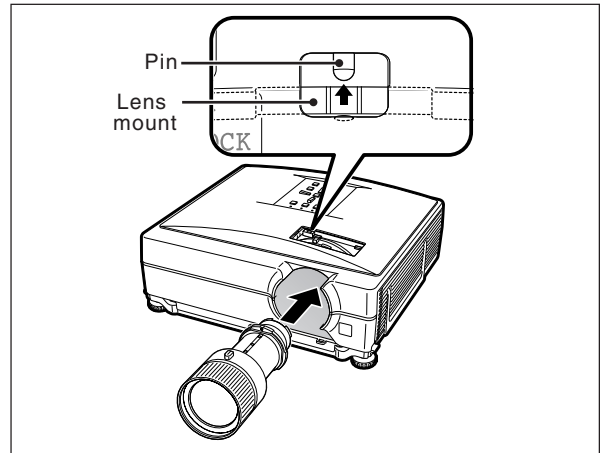

6 Slide the lens fastener catch tab in the direction of "LOCK" until it stops.

- Be careful not to rotate the lens fastener ring too tight, as the lens fastener ring will be difficult to loosen the next time the lens is changed.

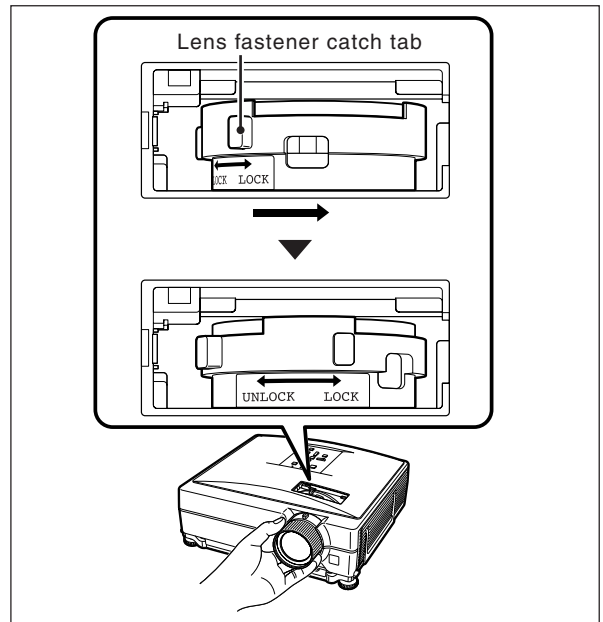

7 Replace the lens housing cover.

- If the lens housing cover is not secured to the projector, you will not be able to turn the power on.

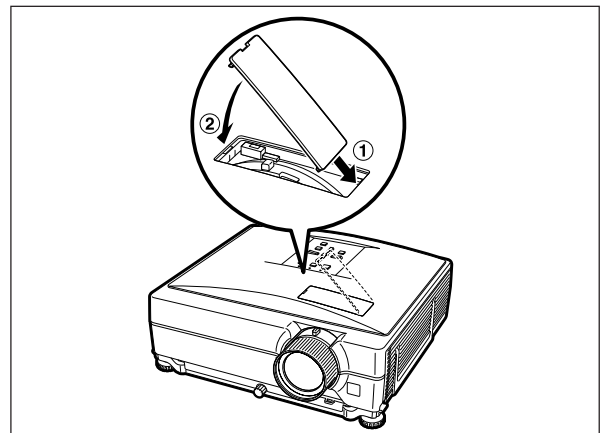

Connecting Pin Assignments

COMPUTER-RGB/COMPONENT INPUT 1, 2 and COMPUTER-RGB/COMPONENT OUTPUT Terminals: 15-pin mini D-sub female connector

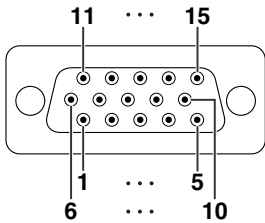

COMPUTER-RGB Input/Output

1. Video input (red)
2. Video input (green/sync on green)
3. Video input (blue)
4. Not connected
5. Not connected
6. Earth (red)
7. Earth (green/sync on green)
8. Earth (blue)
9. Not connected
10. GND
11. Not connected
12. Bi-directional data
13. Horizontal sync signal: TTL level
14. Vertical sync signal: TTL level
15. Data clock

Component Input/Output

1. P_R (C_R)
2. Y
3. P_B (C_B)
4. Not connected
5. Not connected
6. Earth (P_R)
7. Earth (Y)
8. Earth (P_B)
9. Not connected
10. Not connected
11. Not connected
12. Not connected
13. Not connected
14. Not connected
15. Not connected

RS-232C Terminal: 9-pin mini DIN female connector

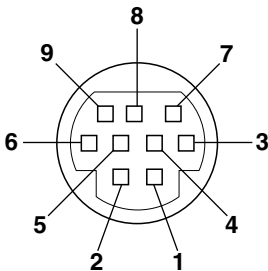

Pin No.	Signal	Name	I/O	Reference
1				Not connected
2	RD	Receive Data	Input	Connected to internal circuit
3	SD	Send Data	Output	Connected to internal circuit
4				Not connected
5	SG	Signal Ground		Connected to internal circuit
6				Not connected
7	RS	Request to Send		Connected to CS in internal circuit
8	CS	Clear to Send		Connected to RS in internal circuit
9				Not connected

RS-232C Terminal: 9-pin D-sub male connector of the DIN-D-sub RS-232C adaptor

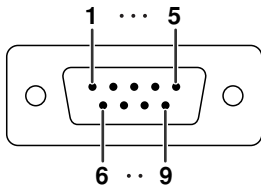

Pin No.	Signal	Name	I/O	Reference
1				Not connected
2	RD	Receive Data	Input	Connected to internal circuit
3	SD	Send Data	Output	Connected to internal circuit
4				Not connected
5	SG	Signal Ground		Connected to internal circuit
6				Not connected
7	RS	Request to Send		Connected to CS in internal circuit
8	CS	Clear to Send		Connected to RS in internal circuit
9				Not connected

RS-232C Cable recommended connection: 9-pin D-sub female connector

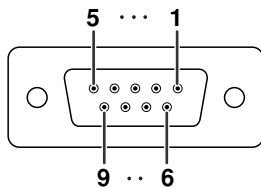

Pin No.	Signal	Pin No.	Signal
1	CD	1	CD
2	RD	2	RD
3	SD	3	SD
4	ER	4	ER
5	SG	5	SG
6	DR	6	DR
7	RS	7	RS
8	CS	8	CS
9	CI	9	CI



Note

- Depending on the controlling device used, it may be necessary to connect Pin 4 and Pin 6 on the controlling device (e.g. computer).



LAN Terminal : 8-pin RJ-45 modular connector

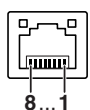

Pin No.	Signal	Pin No.	Signal
1	TX+	5	
2	TX-	6	RX-
3	RX+	7	
4		8	

Connecting Pin Assignments

DVI-D Input Terminal

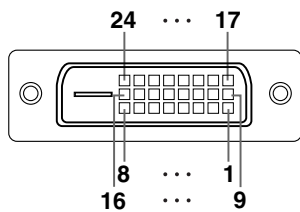

Pin No.	Signal
1	T.M.D.S. Data 2-
2	T.M.D.S. Data 2+
3	T.M.D.S. Data 2 Shield
4	Not connected
5	Not connected
6	DDC Clock
7	DDC Data
8	Not connected
9	T.M.D.S. Data 1-
10	T.M.D.S. Data 1+
11	T.M.D.S. Data 1 Shield
12	Not connected

Pin No.	Signal
13	Not connected
14	+5 V Power
15	Ground
16	Hot Plug Detect
17	T.M.D.S. Data 0-
18	T.M.D.S. Data 0+
19	T.M.D.S. Data 0 Shield
20	Not connected
21	Not connected
22	T.M.D.S. Clock Shield
23	T.M.D.S. Clock+
24	T.M.D.S. Clock-

RS-232C Specifications and Commands

Computer control

A computer can be used to control the projector by connecting an RS-232C serial control cable (cross type, commercially available) to the projector. (See page 27 of the projector's operation manual for connection.)

Communication conditions

Set the serial port settings of the computer to match that of the table.

Signal format: Conforms to RS-232C standard.

Parity bit: None

Baud rate*: 9,600 bps / 38,400 bps / 115,200 bps

Stop bit: 1 bit

Data length: 8 bits

Flow control: None

*Set the projector's baud rate to the same rate as used by the computer.

Basic format

Commands from the computer are sent in the following order: command, parameter, and return code. After the projector processes the command from the computer, it sends a response code to the computer.

Command format

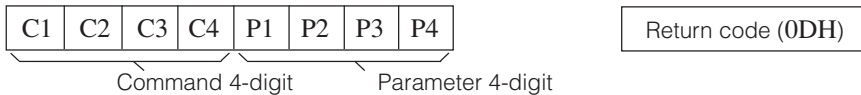

Response code format

Normal response

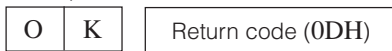

Problem response (communication error or incorrect command)



Info

- When controlling the projector using RS-232C commands from a computer, wait for at least 40 seconds after the power has been turned on, and then transmit the commands.
- After sending an input selection or picture adjustment command and then receiving an "OK" response code, the projector may take some time to process the command. If a second command is sent while the projector is still processing the first command, you may receive an "ERR" response code. If this happens, try resending the second command.
- When more than one code is being sent, send each command only after the response code for the previous command from the projector is verified.
- "POWER???" "TABN ___ 1" "TLPS ___ 1" "TPOW ___ 1" "TLPN ___ 1" "TLTT ___ 1" "TLTL ___ 1" "TNAM ___ 1" "MNRD ___ 1" "PJNO ___ 1"
 - When the projector receives the special commands shown above:
 - * The on-screen display will not disappear.
 - * The "Auto Power Off" timer will not be reset.
 - The special commands are available for applications that require continuous polling.

Note

- If an underbar (_) appears in the parameter column, enter a space.
- If an asterisk (*) appears in the parameter column, enter a value in the range indicated in brackets under Control Contents.
- *1 Serial No. Check command is used to read out the 12 digits of serial No..
- *2 For setting the projector name, send the commands in the order of PJN1, PJN2 and PJN3.
- *3 Parameters of CLR Temp settings are as follows.

CLR Temp	Parameter	CLR Temp	Parameter
5500K	_0 5 5	8500K	_0 8 5
6500K	_0 6 5	9300K	_0 9 3
7500K	_0 7 5	10500K	_1 0 5

- *4 The adjustable range of "V-Pos" (V-Position) may vary depending on the screen resolution of the computer.

RS-232C Specifications and Commands

Commands

Example: When turning on the projector, make the following setting.

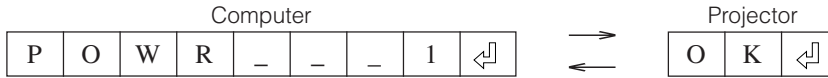

CONTROL CONTENTS	COMMAND	PARAMETER	RETURN	
			Power ON	Standby mode (or 40-second startup time)
Power Off	P O W R	- - - 0	OK or ERR	OK
Power On	P O W R	- - - 1	OK	OK or ERR
Power Status	P O W R	? ? ? ?	1	0
Projector Condition	T A B N	- - - 1	0:Normal 1:Temp High 8:Lamp Life 5% or less 16:Lamp Burnt-out 32:Lamp Ignition Failure	0:Normal 1:Temp High 2:Fan Error 4:Cover Open 8:Lamp Life 5% or less 16:Lamp Burnt-out 32:Lamp Ignition Failure 64:Temp Abnormally High
Lamp Status	T L P S	- - - 1	0:Off, 1:On, 2:Retry, 3:Waiting, 4:Lamp Error	0:Off, 4:Lamp Error
Lamp Power Status	T P O W	- - - 1	1:On, 2:Cooling	0:Standby
Lamp Quantity	T L P N	- - - 1	1	
Lamp Usage Time (Hour)	T L T T	- - - 1	0 - 9999 (Integer)	
Lamp Usage Time (Minute)	T L T M	- - - 1	0, 15, 30, 45	
Lamp Life (Percentage)	T L T L	- - - 1	0% - 100% (Integer)	
Model Name Check	T N A M	- - - 1	XGC465X / XGC435X	
Model Name Check	M N R D	- - - 1	XG-C465X / XG-C435X	
Serial No. Check *1	S N R D	- - - 1	Serial No.	
Projector Name Setting 1 (First four characters) *2	P J N 1	* * * *	OK or ERR	
Projector Name Setting 2 (Middle four characters) *2	P J N 2	* * * *	OK or ERR	
Projector Name Setting 3 (Last four characters) *2	P J N 3	* * * *	OK or ERR	
Projector Name Check	P J N 0	- - - 1	Projector Name	
COMPUTER 1 (RGB1)	I R G B	- - - 1	OK or ERR	ERR
COMPUTER 2 (RGB2)	I R G B	- - - 2	OK or ERR	ERR
DVI (RGB3)	I R G B	- - - 3	OK or ERR	ERR
INPUT RGB Check	I R G B	? ? ? ?	1:RGB1(COMPUTER1), 2:RGB2(COMPUTER2), 3:RGB3(DVI) or ERR	ERR
S-VIDEO (Video1)	I V E D	- - - 1	OK or ERR	ERR
VIDEO (Video2)	I V E D	- - - 2	OK or ERR	ERR
INPUT Video Check	I V E D	? ? ? ?	1:S-Video, 2:Video or ERR	ERR
INPUT Mode Check	I M O D	? ? ? ?	1:RGB, 2:Video	ERR
INPUT Check	I C H K	? ? ? ?	1:COMPUTER1, 2:COMPUTER2, 3:DVI, 4:S-Video, 5:Video	ERR
All Reset	A L R E	- - - 1	OK or ERR	ERR
Volume (0 - 60)	V O L A	- - * *	OK or ERR	ERR
Volume up / down (-10 - +10)	V O U D	- * * *	OK or ERR	ERR
Keystone (-127 - +127)	K E Y S	- * * *	OK or ERR	ERR
AV Mute Off	I M B K	- - - 0	OK or ERR	ERR
AV Mute On	I M B K	- - - 1	OK or ERR	ERR
Freeze Off	F R E Z	- - - 0	OK or ERR	ERR
Freeze On	F R E Z	- - - 1	OK or ERR	ERR
Eco+Quiet Mode : Off	T H M D	- - - 0	OK or ERR	ERR
Eco+Quiet Mode : On	T H M D	- - - 1	OK or ERR	ERR
Auto Sync Start	A D J S	- - - 1	OK or ERR	ERR
COMPUTER 1 Resize : Normal	R A S R	- - - 1	OK or ERR	ERR
COMPUTER 1 Resize : Stretch	R A S R	- - - 2	OK or ERR	ERR
COMPUTER 1 Resize : Dot By Dot	R A S R	- - - 3	OK or ERR	ERR
COMPUTER 1 Resize : Full	R A S R	- - - 5	OK or ERR	ERR
COMPUTER 1 Resize : Border	R A S R	- - - 6	OK or ERR	ERR
COMPUTER 2 Resize : Normal	R B S R	- - - 1	OK or ERR	ERR
COMPUTER 2 Resize : Stretch	R B S R	- - - 2	OK or ERR	ERR
COMPUTER 2 Resize : Dot By Dot	R B S R	- - - 3	OK or ERR	ERR
COMPUTER 2 Resize : Full	R B S R	- - - 5	OK or ERR	ERR
COMPUTER 2 Resize : Border	R B S R	- - - 6	OK or ERR	ERR
DVI Resize : Normal	R C S R	- - - 1	OK or ERR	ERR
DVI Resize : Stretch	R C S R	- - - 2	OK or ERR	ERR
DVI Resize : Dot By Dot	R C S R	- - - 3	OK or ERR	ERR
DVI Resize : Full	R C S R	- - - 5	OK or ERR	ERR
DVI Resize : Border	R C S R	- - - 6	OK or ERR	ERR

RS-232C Specifications and Commands

CONTROL CONTENTS	COMMAND	PARAMETER	RETURN	
			Power ON	Standby mode (or 40-second startup time)
S-Video Resize : Normal	R A S V	- - - 1	OK or ERR	ERR
S-Video Resize : Stretch	R A S V	- - - 2	OK or ERR	ERR
S-Video Resize : Border	R A S V	- - - 3	OK or ERR	ERR
S-Video Resize : Area Zoom	R A S V	- - 1 0	OK or ERR	ERR
S-Video Resize : V-Stretch	R A S V	- - 1 1	OK or ERR	ERR
Video Resize : Normal	R B S V	- - - 1	OK or ERR	ERR
Video Resize : Stretch	R B S V	- - - 2	OK or ERR	ERR
Video Resize : Border	R B S V	- - - 3	OK or ERR	ERR
Video Resize : Area Zoom	R B S V	- - 1 0	OK or ERR	ERR
Video Resize : V-Stretch	R B S V	- - 1 1	OK or ERR	ERR
COMPUTER 1 Adjustment Reset	R A R E	- - - 1	OK or ERR	ERR
COMPUTER 2 Adjustment Reset	R B R E	- - - 1	OK or ERR	ERR
DVI Adjustment Reset	R C R E	- - - 1	OK or ERR	ERR
S-VIDEO Adjustment Reset	V A R E	- - - 1	OK or ERR	ERR
VIDEO Adjustment Reset	V B R E	- - - 1	OK or ERR	ERR
COMPUTER 1 Picture Mode : Standard	R A P S	- - - 1 0	OK or ERR	ERR
COMPUTER 1 Picture Mode : Presentation	R A P S	- - - 1 1	OK or ERR	ERR
COMPUTER 1 Picture Mode : Movie	R A P S	- - - 1 2	OK or ERR	ERR
COMPUTER 1 Picture Mode : Game	R A P S	- - - 1 3	OK or ERR	ERR
COMPUTER 1 Picture Mode : sRGB	R A P S	- - - 1 4	OK or ERR	ERR
COMPUTER 1 Contrast (-30 - +30)	R A P I	- * * *	OK or ERR	ERR
COMPUTER 1 Bright (-30 - +30)	R A B R	- * * *	OK or ERR	ERR
COMPUTER 1 Color (-30 - +30)	R A C O	- * * *	OK or ERR	ERR
COMPUTER 1 Tint (-30 - +30)	R A T I	- * * *	OK or ERR	ERR
COMPUTER 1 Red (-30 - 30)	R A R D	- * * *	OK or ERR	ERR
COMPUTER 1 Blue (-30 - +30)	R A B E	- * * *	OK or ERR	ERR
COMPUTER 1 Sharp (-30 - +30)	R A S H	- * * *	OK or ERR	ERR
COMPUTER 1 CLR Temp *3	R A C T	- * * *	OK or ERR	ERR
COMPUTER 1 Progressive : 2D	R A I P	- - - 0	OK or ERR	ERR
COMPUTER 1 Progressive : 3D	R A I P	- - - 1	OK or ERR	ERR
COMPUTER 1 Signal Type : Auto	I A S I	- - - 0	OK or ERR	ERR
COMPUTER 1 Signal Type : RGB	I A S I	- - - 1	OK or ERR	ERR
COMPUTER 1 Signal Type : Component	I A S I	- - - 2	OK or ERR	ERR
COMPUTER 2 Picture Mode : Standard	R B P S	- - - 1 0	OK or ERR	ERR
COMPUTER 2 Picture Mode : Presentation	R B P S	- - - 1 1	OK or ERR	ERR
COMPUTER 2 Picture Mode : Movie	R B P S	- - - 1 2	OK or ERR	ERR
COMPUTER 2 Picture Mode : Game	R B P S	- - - 1 3	OK or ERR	ERR
COMPUTER 2 Picture Mode : sRGB	R B P S	- - - 1 4	OK or ERR	ERR
COMPUTER 2 Contrast (-30 - +30)	R B P I	- * * *	OK or ERR	ERR
COMPUTER 2 Bright (-30 - +30)	R B B R	- * * *	OK or ERR	ERR
COMPUTER 2 Color (-30 - +30)	R B C O	- * * *	OK or ERR	ERR
COMPUTER 2 Tint (-30 - +30)	R B T I	- * * *	OK or ERR	ERR
COMPUTER 2 Red (-30 - +30)	R B R D	- * * *	OK or ERR	ERR
COMPUTER 2 Blue (-30 - +30)	R B B E	- * * *	OK or ERR	ERR
COMPUTER 2 Sharp (-30 - +30)	R B S H	- * * *	OK or ERR	ERR
COMPUTER 2 CLR Temp *3	R B C T	- * * *	OK or ERR	ERR
COMPUTER 2 Progressive : 2D	R B I P	- - - 0	OK or ERR	ERR
COMPUTER 2 Progressive : 3D	R B I P	- - - 1	OK or ERR	ERR
COMPUTER 2 Signal Type : Auto	I B S I	- - - 0	OK or ERR	ERR
COMPUTER 2 Signal Type : RGB	I B S I	- - - 1	OK or ERR	ERR
COMPUTER 2 Signal Type : Component	I B S I	- - - 2	OK or ERR	ERR
DVI Picture Mode : Standard	R C P S	- - - 1 0	OK or ERR	ERR
DVI Picture Mode : Presentation	R C P S	- - - 1 1	OK or ERR	ERR
DVI Picture Mode : Movie	R C P S	- - - 1 2	OK or ERR	ERR
DVI Picture Mode : Game	R C P S	- - - 1 3	OK or ERR	ERR
DVI Picture Mode : sRGB	R C P S	- - - 1 4	OK or ERR	ERR
DVI Contrast (-30 - +30)	R C P I	- * * *	OK or ERR	ERR
DVI Bright (-30 - +30)	R C B R	- * * *	OK or ERR	ERR
DVI Red (-30 - +30)	R C R D	- * * *	OK or ERR	ERR
DVI Blue (-30 - +30)	R C B E	- * * *	OK or ERR	ERR
DVI CLR Temp *3	R C C T	- * * *	OK or ERR	ERR

RS-232C Specifications and Commands

CONTROL CONTENTS	COMMAND	PARAMETER	RETURN	
			Power ON	Standby mode (or 40-second startup time)
DVI Signal Type : D. PC RGB	I C S I	3	OK or ERR	ERR
DVI Signal Type : D. PC Comp.	I C S I	4	OK or ERR	ERR
DVI Signal Type : D. Video RGB	I C S I	5	OK or ERR	ERR
DVI Signal Type : D. Video Comp.	I C S I	6	OK or ERR	ERR
DVI Dynamic Range : Standard	H M C D	1	OK or ERR	ERR
DVI Dynamic Range : Enhanced	H M C D	2	OK or ERR	ERR
S-Video Picture Mode : Standard	V A P S	0	OK or ERR	ERR
S-Video Picture Mode : Presentation	V A P S	1	OK or ERR	ERR
S-Video Picture Mode : Movie	V A P S	2	OK or ERR	ERR
S-Video Picture Mode : Game	V A P S	3	OK or ERR	ERR
S-Video Contrast (-30 - +30)	V A P I	*	OK or ERR	ERR
S-Video Bright (-30 - +30)	V A B R	*	OK or ERR	ERR
S-Video Color (-30 - +30)	V A C O	*	OK or ERR	ERR
S-Video Tint (-30 - +30)	V A T I	*	OK or ERR	ERR
S-Video Red (-30 - +30)	V A R D	*	OK or ERR	ERR
S-Video Blue (-30 - +30)	V A B E	*	OK or ERR	ERR
S-Video Sharp (-30 - +30)	V A S H	*	OK or ERR	ERR
S-Video CLR Temp *3	V A C T	*	OK or ERR	ERR
S-Video Progressive : 2D	V A I P	0	OK or ERR	ERR
S-Video Progressive : 3D	V A I P	1	OK or ERR	ERR
Video Picture Mode : Standard	V B P S	0	OK or ERR	ERR
Video Picture Mode : Presentation	V B P S	1	OK or ERR	ERR
Video Picture Mode : Movie	V B P S	2	OK or ERR	ERR
Video Picture Mode : Game	V B P S	3	OK or ERR	ERR
Video Contrast (-30 - +30)	V B P I	*	OK or ERR	ERR
Video Bright (-30 - +30)	V B B R	*	OK or ERR	ERR
Video Color (-30 - +30)	V B C O	*	OK or ERR	ERR
Video Tint (-30 - +30)	V B T I	*	OK or ERR	ERR
Video Red (-30 - +30)	V B R D	*	OK or ERR	ERR
Video Blue (-30 - +30)	V B B E	*	OK or ERR	ERR
Video Sharp (-30 - +30)	V B S H	*	OK or ERR	ERR
Video CLR Temp *3	V B C T	*	OK or ERR	ERR
Video Progressive : 2D	V B I P	0	OK or ERR	ERR
Video Progressive : 3D	V B I P	1	OK or ERR	ERR
Video System Selection : AUTO	M E S Y	1	OK or ERR	ERR
Video System Selection : PAL	M E S Y	2	OK or ERR	ERR
Video System Selection : SECAM	M E S Y	3	OK or ERR	ERR
Video System Selection : NTSC4.43	M E S Y	4	OK or ERR	ERR
Video System Selection : NTSC3.58	M E S Y	5	OK or ERR	ERR
Video System Selection : PAL_M	M E S Y	6	OK or ERR	ERR
Video System Selection : PAL_N	M E S Y	7	OK or ERR	ERR
Video System Selection : PAL-60	M E S Y	8	OK or ERR	ERR
Clock (-30 - +30)	I N C L	*	OK or ERR	ERR
Phase (-15 - +15)	I N P H	*	OK or ERR	ERR
H-Position (-30 - +30)	I A H P	*	OK or ERR	ERR
V-Position (-30 - +30) *4	I A V P	*	OK or ERR	ERR
Fine Sync Adjustment Reset	I A R E	1	OK or ERR	ERR
Auto Sync : Off	A A D J	0	OK or ERR	ERR
Auto Sync : On	A A D J	1	OK or ERR	ERR
RGB Horizontal Frequency Check	T F R Q	1	x10 ⁻¹ kHz (***. * or ERR)	ERR
RGB Vertical Frequency Check	T F R Q	2	Hz (**. * or ERR)	ERR
Image Shift (-96 - +96)	L N D S	*	OK or ERR	ERR
Auto Keystone : Off	A T K S	0	OK or ERR	ERR
Auto Keystone : On	A T K S	1	OK or ERR	ERR
OSD Display : Off	I M D I	0	OK or ERR	ERR
OSD Display : On	I M D I	1	OK or ERR	ERR
Background Selection : Logo	I M B G	1	OK or ERR	ERR
Background Selection : Blue	I M B G	3	OK or ERR	ERR
Background Selection : None	I M B G	4	OK or ERR	ERR
Auto Power Off : Off	A P O W	0	OK or ERR	ERR
Auto Power Off : On	A P O W	1	OK or ERR	ERR
System Sound : Off	S S N D	0	OK or ERR	ERR
System Sound : On	S S N D	1	OK or ERR	ERR
Auto Restart : Off	A R E S	0	OK or ERR	ERR
Auto Restart : On	A R E S	1	OK or ERR	ERR

RS-232C Specifications and Commands

CONTROL CONTENTS	COMMAND	PARAMETER	RETURN	
			Power ON	Standby mode (or 40-second startup time)
Internal Speaker : Off	A S P K	- - - 0	OK or ERR	ERR
Internal Speaker : On	A S P K	- - - 1	OK or ERR	ERR
Audio Out : FAO	A O U T	- - - 1	OK or ERR	ERR
Audio Out : VAO	A O U T	- - - 2	OK or ERR	ERR
PRJ Mode : Reverse Off	I M R E	- - - 0	OK or ERR	ERR
PRJ Mode : Reverse On	I M R E	- - - 1	OK or ERR	ERR
PRJ Mode : Invert Off	I M I N	- - - 0	OK or ERR	ERR
PRJ Mode : Invert On	I M I N	- - - 1	OK or ERR	ERR
Fan Mode : Normal	H L M D	- - - 0	OK or ERR	ERR
Fan Mode : High	H L M D	- - - 1	OK or ERR	ERR
Monitor Out : Disable	M O U T	- - - 0	OK or ERR	ERR
Monitor Out : Enable	M O U T	- - - 1	OK or ERR	ERR
Language Selection : ENGLISH	M E L A	- - - 1	OK or ERR	ERR
Language Selection : DEUTSCH	M E L A	- - - 2	OK or ERR	ERR
Language Selection : ESPAÑOL	M E L A	- - - 3	OK or ERR	ERR
Language Selection : NEDERLANDS	M E L A	- - - 4	OK or ERR	ERR
Language Selection : FRANÇAIS	M E L A	- - - 5	OK or ERR	ERR
Language Selection : ITALIANO	M E L A	- - - 6	OK or ERR	ERR
Language Selection : SVENSKA	M E L A	- - - 7	OK or ERR	ERR
Language Selection : 日本語	M E L A	- - - 8	OK or ERR	ERR
Language Selection : PORTUGUES	M E L A	- - - 9	OK or ERR	ERR
Language Selection : 汉语	M E L A	- - 1 0	OK or ERR	ERR
Language Selection : 한국어	M E L A	- - 1 1	OK or ERR	ERR
Language Selection : русский	M E L A	- - 1 2	OK or ERR	ERR
Language Selection : عربي	M E L A	- - 1 3	OK or ERR	ERR
Language Selection : polski	M E L A	- - 1 4	OK or ERR	ERR
Language Selection : Türkçe	M E L A	- - 1 5	OK or ERR	ERR
Lamp Timer Reset *5	L P R E	0 0 0 1	ERR	OK or ERR

*5 Lamp Timer Reset command is available only in standby mode.

PJLink™ Compliant:

This product conforms with the PJLink standard Class 1 and all Class 1 commands are implemented.

This product conforms with the PJLink standard specification version 1.00.

For additional information, visit "<http://pjlink.jbmia.or.jp/english/>".

Setting up the Projector Network Environment

This section describes the basic procedure for using the projector via the network.

If the network is already constructed, the projector's network settings may need to be changed. Please consult your network administrator for assistance with these settings.

You can make network settings both on the projector and on the computer. The following procedure is for making settings on the computer.

Network settings on the computer

1. Connecting the projector to a computer

Connect a LAN cable (Category 5, cross-over type) between the computer and projector.

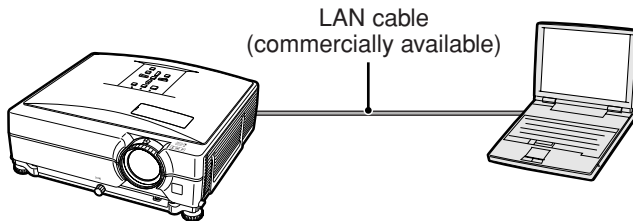

→ Page 19

2. Setting an IP address for the computer

Adjust the IP settings of the computer to enable one-to-one communications with the projector.

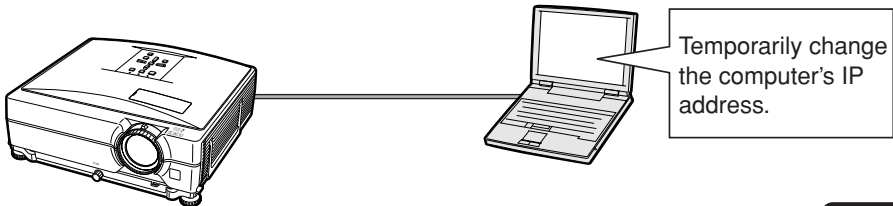

→ Pages 20, 21

3. Setting up a network connection for the projector

Adjust the projector network settings to conform to your network.

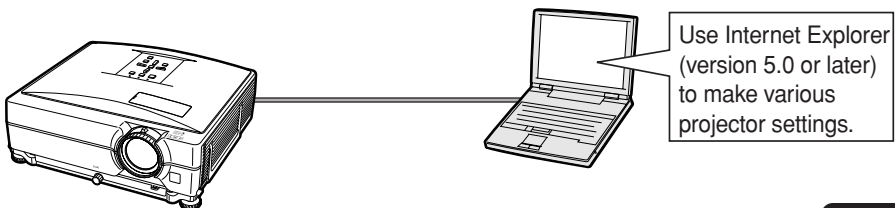

→ Pages 22, 23

- Microsoft® and Windows® are registered trademarks of Microsoft Corporation in the United States and/or other countries.
- All other company or product names are trademarks or registered trademarks of their respective companies.

1. Connecting the Projector to a Computer

Establishing a one-to-one connection from the projector to a computer. Using a LAN cable (Category 5, cross-over type) you can configure the projector via the computer.

- 1 Disconnect the computer's LAN cable from the existing network.

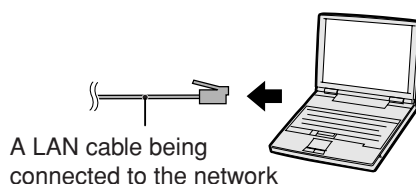

- 2 Connect a LAN cable (a UTP cable, Category 5, cross-over type) to the projector's LAN terminal and connect the other end of the cable to the computer's LAN terminal.

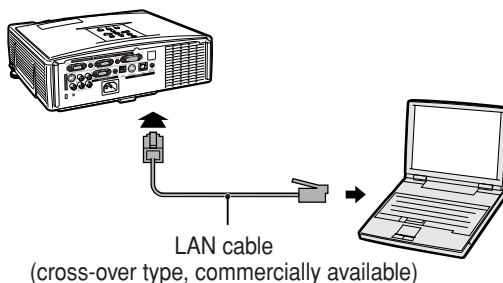

- 3 Plug the power cord into the AC socket of the projector.

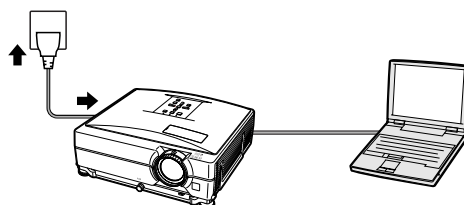

- 4 Turn on the computer.

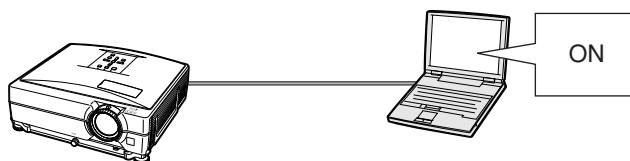

Info

Confirm that the LINK LED on the rear of the projector illuminates. If the LINK LED does not illuminate, check the following :

- The LAN cable is properly connected.
- The power switches of both the projector and the computer are on.

This completes the connection. Now proceed to “2. Setting an IP Address for the Computer”.

Setting up the Projector Network Environment

2. Setting an IP Address for the Computer

The following describes how to make settings in Windows® XP (Professional or Home Edition).

1 Log on the network using the administrator's account for the computer.

2 Click "Start", and click "Control Panel".

3 Click "Network and Internet Connections", and click "Network Connections" in the new window.

- This manual uses examples to explain the operations in Category View. If you are using Classic View, double-click "Network Connections".

4 Right-click "Local Area Connection" and select "Properties" from the menu.

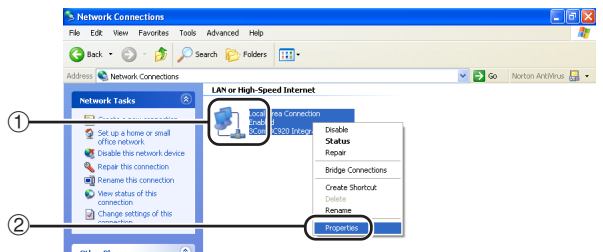
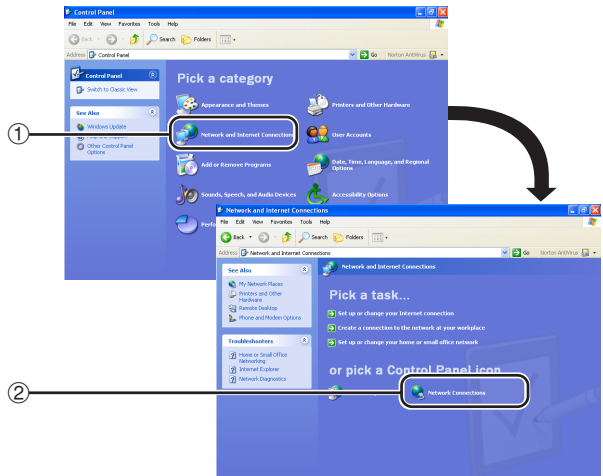
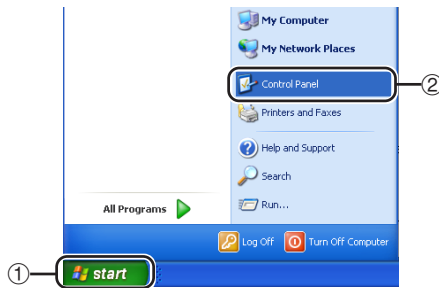

Setting up the Projector Network Environment

- 5** Click “Internet Protocol (TCP/IP)”, and click the “Properties” button.

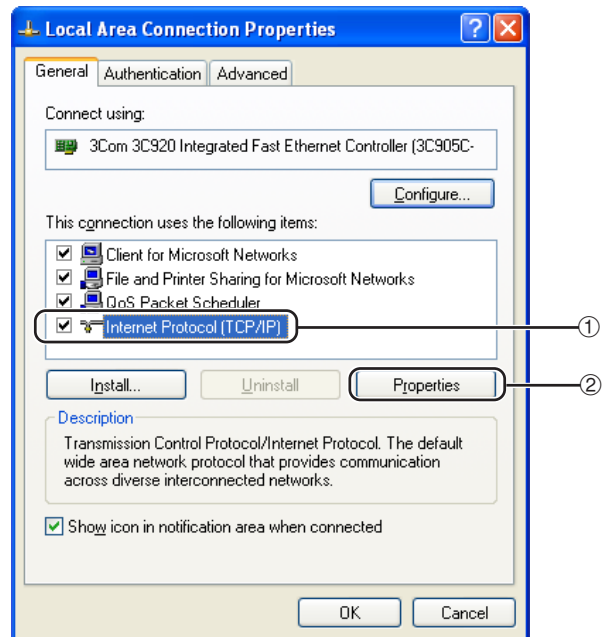

- 6** Confirm or change an IP address for the setup computer.

- ① Confirm and note the current IP address, Subnet mask and Default gateway.

Make sure to note the current IP address, Subnet mask and Default gateway as you will be required to reset them later.

- ② Set temporarily as follows :
IP address : 192.168.150.3
Subnet mask : 255.255.255.0
Default gateway : (Do not input any values.)

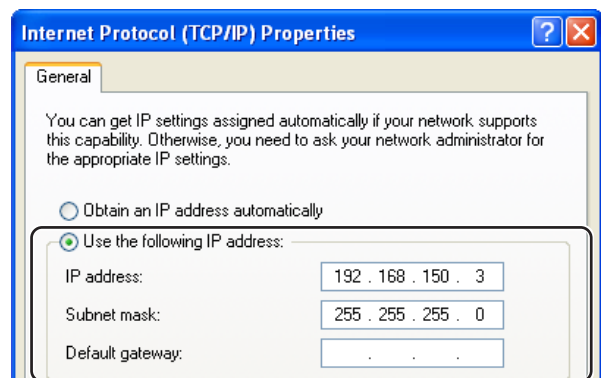

Note

- The factory default settings for the projector are as follows:
DHCP Client : Off
IP address : 192.168.150.2
Subnet mask : 255.255.255.0
Default gateway : 0.0.0.0

- 7** After setting, click the “OK” button, and then restart the computer.

After confirming or setting, proceed to “3. Setting up Network Connection for the Projector”.

Setting up the Projector Network Environment

3. Setting up a Network Connection for the Projector

Settings for such items as the projector's IP address and subnet mask are compatible with the existing network.

Set each item on the projector as follows. (See page 53 of the projector's operation manual for setting.)

DHCP Client : Off

IP Address : 192.168.150.002

Subnet Mask : 255.255.255.000

1 Start Internet Explorer (version 5.0 or later) on the computer, and enter "http://192.168.150.2/" in "Address", and then press the "Enter" key.

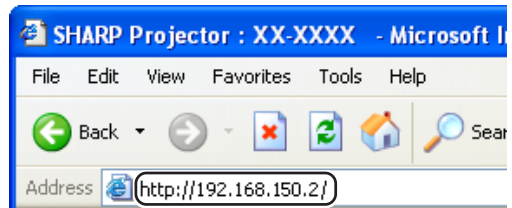

2 If a user name and a password have not yet been set, just click the "OK" button.

- If a user name and a password have been set, input the user name and the password, and click the "OK" button.
- If the user name or password is entered incorrectly three times, an error message will be displayed.



3 When the screen as shown on the right appears, click "TCP/IP".

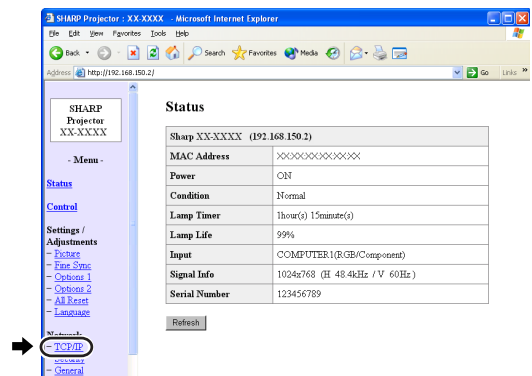

4 The TCP/IP setting screen appears, ready for network settings for the projector.

Items	Setting example / Remarks
DHCP Client	Select "ON" or "OFF" to determine whether to use DHCP Client.
IP Address	You can set this item when "DHCP Client" is set to "OFF". Factory default setting: 192.168.150.2 Enter an IP address appropriate for the network.
Subnet Mask	You can set this item when "DHCP Client" is set to "OFF". Factory default setting: 255.255.255.0 Set the subnet mask to the same as that of the computer and equipment on the network.
Default Gateway	You can set this item when "DHCP Client" is set to "OFF". Factory default setting: 0.0.0.0 * When not in use, set to "0.0.0.0".
DNS Server	Factory default setting: 0.0.0.0 * When not in use, set to "0.0.0.0".

Note

- Confirm the existing network's segment (IP address group) to avoid setting an IP address that duplicates the IP addresses of other network equipment or computers. If "192.168.150.2" is not used in the network having an IP address of "192.168.150.XXX", you don't have to change the projector IP address.
- For details about each setting, consult your network administrator.

5 Click the "Apply" button.

6 The set values appear. Confirm that the values are set properly, and then click the "Confirm" button.

- Close the browser.
- This completes the network settings.
- After setting items, wait for 10 seconds and then re-access.
- Change the IP address of the setting computer back to its original address, which you have noted down in Step 6-① on page 21, and then connect the computer and the projector to the network.

Network - TCP/IP

DHCP Client	<input checked="" type="radio"/> OFF <input type="radio"/> ON
IP Address	192 168 150 2
Subnet Mask	255 255 255 0
Default Gateway	0 0 0 0 * '0.0.0.0' means 'Using no default gateway.'
Default DNS Server	0 0 0 0 * '0.0.0.0' means 'Using no DNS server.'

Network - TCP/IP

DHCP Client	<input checked="" type="radio"/> OFF <input type="radio"/> ON
IP Address	192 168 150 2
Subnet Mask	255 255 255 0
Default Gateway	0 0 0 0 * '0.0.0.0' means 'Using no default gateway.'
Default DNS Server	0 0 0 0 * '0.0.0.0' means 'Using no DNS server.'



Refresh

Network - TCP/IP

The TCP/IP settings will be changed as below.

DHCP Client : OFF
IP Address : 192.168.150.2
Subnet Mask : 255.255.255.0
Default Gateway : 0.0.0.0
DNS Server : 0.0.0.0

Do you want to change the TCP/IP settings?



After you click "Confirm", if you want to continue to operate this projector via the network, please wait for 10 seconds and then re-access to "192.168.150.2".

Controlling the Projector via LAN

After connecting the projector to your network, enter the projector IP address in “Address” on Internet Explorer (version 5.0 or later) using a computer on the network to start a setup screen that will enable control of the projector via the network.

Controlling the Projector Using Internet Explorer (Version 5.0 or later)

Complete connections to external equipment before starting the operation. (See pages 21-29 of the projector’s operation manual.) Complete the AC cord connection. (See page 30 of the projector’s operation manual.)

Note

- When connecting the projector to the LAN, use a LAN cable (Category 5). When connecting the projector to a hub, use a straight-through cable.

1 Start Internet Explorer (version 5.0 or later) on the computer.

2 Enter “http://” followed by the projector IP address set by the procedure on page 23 followed by “/” in “Address”, and then press the “Enter” key.

- The factory default setting for the projector : “DHCP Client” is “Off” and IP address is “192.168.150.2”. If you did not change the IP address in “3. Setting up a Network Connection for the Projector” (pages 22-23), enter “http://192.168.150.2”.

3 A screen for controlling the projector appears, ready for performing various status conditions, control, and settings.

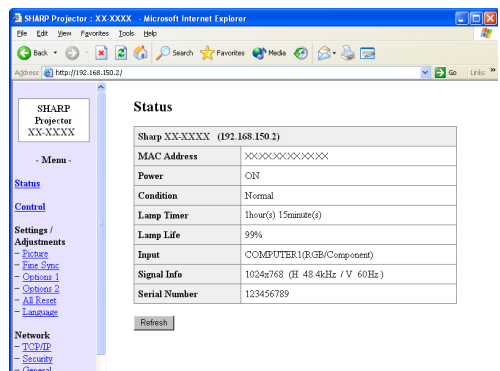
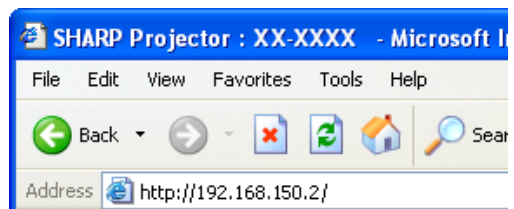

Confirming the Projector Status (Status)

Status

Sharp XX-XXXX (192.168.150.2)	
MAC Address	XXXXXXXXXXXXXX
Power	ON
Condition	Normal
Lamp Timer	1hour(s) 15minute(s)
Lamp Life	99%
Input	COMPUTER1(RGB/Component)
Signal Info	1024x768 (H 48.4kHz / V 60Hz)
Serial Number	123456789

Refresh

On this screen, you can confirm the projector status. You can confirm the following items :

- MAC Address
- Power
- Condition
- Lamp Timer
- Lamp Life
- Input
- Signal Info
- Serial Number

Note

- If you click the “Refresh” button before the screen is displayed completely, an error message (“Server Busy Error”) will be displayed. Wait for a moment and then operate again.
- For details about each item, refer to the projector’s operation manual.

Controlling the Projector (Control)

Control

Power	<input type="radio"/> STANDBY <input checked="" type="radio"/> ON
Input Select	COMPUTER1(RGB/Component) ▾
Volume	1 ▾
AV Mute	<input checked="" type="radio"/> OFF <input type="radio"/> ON

Refresh

On this screen, you can perform projector control. You can control the following items :

- Power
- Input Select
- Volume
- AV Mute

Note

- If you click the “Refresh” button before the screen is displayed completely, an error message (“Server Busy Error”) will be displayed. Wait for a moment and then operate again.
- You cannot operate this page while the projector is warming up.
- While the projector is in standby mode, you can only control “Power ON”.
- For details about each item, refer to the projector’s operation manual.

Controlling the Projector via LAN

Setting and Adjusting the Projector (Settings & Adjustments)

Example: "Picture" screen display for COMPUTER1

Settings / Adjustments - Picture (COMPUTER1)

Picture Mode	Presentation ▾
CLR Temp.	8500K ▾

Reset

Signal Type	Auto ▾
-------------	--------

Refresh

On these screens, you can make projector settings or adjustments. You can set or adjust the following items :

- Picture Mode
- CLR Temp
- Progressive (Video)
- Signal Type (Computer, DVI)
- Dynamic Range (DVI)
- Video System (Video)
- Resolution Setting
- Auto Sync
- Resize
- Auto Keystone
- OSD Display
- Background
- Eco+Quiet Mode
- Auto Power Off
- System Sound
- Menu Position
- Auto Restart
- Password
- Internal Speaker
- Audio Out
- Projection Mode
- Fan Mode
- Monitor Out
- RS-232C Speed
- All Reset
- Language

Note

- If you click the "Refresh" button before the screen is displayed completely, an error message ("Server Busy Error") will be displayed. Wait for a moment and then operate again.
- You cannot operate this page while the projector is warming up.
- For details about each item, refer to the projector's operation manual.

Setting the Security (Network - Security)

Network - Security

User Name	<input type="text"/> (MAX 8 characters)
Password	<input type="text"/> (MAX 8 characters)

This user name / password is for accessing via Web browser and Telnet.

*You will need to re-login with the new user name / new password after you change the user name / password.

Accept IP Address	<input checked="" type="radio"/> All IP Addresses
	<input type="radio"/> From only specific IP addresses
	Address 1 <input type="text"/> <input type="text"/> <input type="text"/> <input type="text"/>
	Address 2 <input type="text"/> <input type="text"/> <input type="text"/> <input type="text"/>
	Address 3 <input type="text"/> <input type="text"/> <input type="text"/> <input type="text"/>

Apply

Refresh

On this screen, you can make settings relating to security.

Items	Description
User Name	Setting of user name for security protection.
Password	Setting of password for security protection.
Accept IP Address	It is possible to set up to three IP addresses allowing connection to the projector.
All IP Addresses	No limits are set to IP addresses connecting to the projector.
From only specific IP addresses	For security improvement, only an IP address set by "Address 1-3" can be connected to the projector.

Note

- User Name and Password can be up to 8 characters.
- You can input the characters below :
a-z, A-Z, 0-9, -, _

Making General Settings for the Network (Network - General)

Network - General

Projector Name	<input type="text" value="XX-XXXX"/> (MAX 12 characters)
Auto Logout Time	<input type="text" value="5"/> minute(s) (0-65535) * If the set value is made 0, the Auto Logout function is disabled.
Data Port	<input type="text" value="10002"/> (1025-65535)
Search Port	<input type="text" value="5006"/> (1025-65535)

On this screen, you can make general settings relating to the network.

Items	Description
Projector Name	Setting the projector name.
Auto Logout Time	Setting the time interval in which the projector will be automatically disconnected from the network in units of a minute (from 1 to 65535 minutes). If the set value is made 0, the Auto Logout function is disabled.
Data Port	Setting the TCP port number used when exchanging data with the projector (from 1025 to 65535).
Search Port	Setting the port number used when searching for the projector (from 1025 to 65535).

After clicking the “Apply” button, the set values appear. Confirm that the values are set properly, and then click the “Confirm” button.

Note

- After setting items, wait for 10 seconds and then re-access.
- Projector Name can be up to 12 characters.
- You can input the characters below : A-Z, 0-9, -, _ , (,) , space
(When “a-z” are input, they are converted to “A-Z” automatically.)

Setting for Sending E-mail when an Error Occurs (Mail – Originator Settings)

Mail - Originator Settings

SMTP Server	<input type="text"/> (MAX 64 characters)
Originator E-mail Address	<input type="text"/> (MAX 64 characters)
Originator Name	<input type="text"/> (MAX 64 characters)

On this screen, you can make settings for sending e-mail to report when the projector has generated an error.

Items	Setting example / Remarks
SMTP Server	Setting an SMTP server address for e-mail transmission. e.g.1 : 192.168.150.253 e.g.2 : smtp123.sharp.co.jp * When using a domain name, make settings for the DNS server.
Originator E-mail Address	Setting the projector's e-mail address. The e-mail address set here becomes Originator E-mail Address.
Originator Name	Setting the sender's name. The name set here appears in the “Originator Name” column of the body of the message.

Note

- SMTP Server, Originator E-mail Address and Originator Name can be up to 64 characters.
- You can input the characters below : SMTP Server and Originator E-mail Address : a-z, A-Z, 0-9, !, #, \$, %, &, *, +, -, /, =, ?, ^, {, |, }, ~, _ , ' , , @ , ` (You can input “@” only one time for “Originator E-mail Address”.)
Originator Name : a-z, A-Z, 0-9, -, _ , (,) , space
- If the settings of “3. Setting up a Network Connection for the Projector” on pages 22 and 23 are incorrectly set, e-mail will not be send.

Controlling the Projector via LAN

Setting Error Items and Destination Addresses to which E-mail is to be Sent when an Error Occurs (Mail – Recipient Settings)

Mail - Recipient Settings

Recipient Addresses	E-mail Address (MAX 64 characters)	Error Mail				Test
		Lamp	Temp	Fan	Cover	
1	<input type="text"/>	<input type="checkbox"/>	<input type="checkbox"/>	<input type="checkbox"/>	<input type="checkbox"/>	<input type="button" value="Test"/>
2	<input type="text"/>	<input type="checkbox"/>	<input type="checkbox"/>	<input type="checkbox"/>	<input type="checkbox"/>	<input type="button" value="Test"/>
3	<input type="text"/>	<input type="checkbox"/>	<input type="checkbox"/>	<input type="checkbox"/>	<input type="checkbox"/>	<input type="button" value="Test"/>
4	<input type="text"/>	<input type="checkbox"/>	<input type="checkbox"/>	<input type="checkbox"/>	<input type="checkbox"/>	<input type="button" value="Test"/>
5	<input type="text"/>	<input type="checkbox"/>	<input type="checkbox"/>	<input type="checkbox"/>	<input type="checkbox"/>	<input type="button" value="Test"/>

On this screen, you can input e-mail destinations to which error notification (error items) e-mails are sent.

Items	Description
E-mail Address	Set addresses to which error notification e-mail is sent. You can set up to five addresses.
Error Mail (Lamp, Temp, Fan, Cover)	Error e-mail is sent on the error items checked in their check boxes.
Test	Send test e-mail. This allows you to confirm that the settings for e-mail transmission are properly set.

Note

- E-mail Address can be up to 64 characters.
- You can input the characters below :
a-z, A-Z, 0-9, !, #, \$, %, &, *, +, -, /, =, ?, ^, {, |, }, ~, _ , ' , . , @ , ` (You can input "@" only one time.)
- For details about error items, refer to the projector's operation manual.

Setting Error Items and the URL that are to be Displayed when an Error Occurs (Service & Support – Access URL)

Service & Support - Access URL Registration

Access URL	(MAX 64 characters)	Condition				Test
		Always	Lamp	Temp	Fan	
1	<input type="text"/>	<input type="checkbox"/>	<input type="checkbox"/>	<input type="checkbox"/>	<input type="checkbox"/>	<input type="button" value="Test"/>
2	<input type="text"/>	<input type="checkbox"/>	<input type="checkbox"/>	<input type="checkbox"/>	<input type="checkbox"/>	<input type="button" value="Test"/>
3	<input type="text"/>	<input type="checkbox"/>	<input type="checkbox"/>	<input type="checkbox"/>	<input type="checkbox"/>	<input type="button" value="Test"/>
4	<input type="text"/>	<input type="checkbox"/>	<input type="checkbox"/>	<input type="checkbox"/>	<input type="checkbox"/>	<input type="button" value="Test"/>
5	<input type="text"/>	<input type="checkbox"/>	<input type="checkbox"/>	<input type="checkbox"/>	<input type="checkbox"/>	<input type="button" value="Test"/>

On this screen, you can make settings of the URL and error items that are to be displayed when the projector has generated an error.

Items	Description
Access URL	Set the URL that is to be displayed when an error occurs. You can set up to five addresses.
Condition (Always, Lamp, Temp, Fan, Cover)	The URL is displayed when an error checked in their check boxes occurs.
Test	The set URL site is test-displayed. This allows you to confirm that the URL site is properly displayed.

Example of the display when an error occurs Status

Sharp XX-XXXX (192.168.150.2)	
MAC Address	XXXXXXXXXXXXXX
Power	STANDBY
	The cooling fan is not operating.
Condition	Access URL 1 http://www.sharp-world.com/projector/
Lamp Timer	1hour(s) 15minute(s)
Lamp Life	99%
Input	----
Signal Info	----
Serial Number	1234567

Setting up the Projector Using RS-232C or Telnet

Connect the projector to a computer using RS-232C or Telnet, and open the SETUP MENU on the computer to carry out various settings for the projector.

When Connecting Using RS-232C

1 Launch general purpose terminal emulator.

2 Input settings for the RS-232C port of the terminal emulator as follows.

Baud Rate : 9600 bps*
Data Length : 8 bit
Parity Bit : None
Stop Bit : 1 bit
Flow Control : None

* This is the factory default setting. If the value of Baud Rate for the projector has been changed, set Baud Rate here according to the changed value on the projector.

3 Input “PJS11234” and press the “Enter” key.

4 “OK” is displayed. Input “PJS25678” and press the “Enter” key within 10 seconds.

5 “User Name:” is displayed. Input the user name and press the “Enter” key.

• If a user name has not yet been set, just press the “Enter” key.

6 “Password:” is displayed. Input the password and press the “Enter” key.

• If a password has not yet been set, just press the “Enter” key.

7 Input “setup” and press the “Enter” key.

• SETUP MENU will be displayed.

▼SETUP MENU

```
-----SETUP MENU-----  
[1]IP Address      [2]Subnet Mask    [3]Default Gateway  
[4]User Name      [5]Password  
[6]RS-232C Baud Rate [7]Projector Name [8]DHCP Client  
[A]Advanced Setup  [D]Disconnect All  
[V]View All Setting [S]Save & Quit    [Q]Quit Unchanged  
  
setup>
```

Note

- User name and password are not set in the factory default settings.
- If the user name or password is entered incorrectly three times, SETUP MENU will be quit.

Setting up the Projector Using RS-232C or Telnet

When Connecting Using Telnet

1 Click “Start” from the Windows® desktop and select “Run”.

2 Enter “telnet 192.168.150.2” in the text box that opens up. (If the IP address of the projector is 192.168.150.2.)

3 Click the “OK” button.

4 “User Name:” is displayed. Input the user name and press the “Enter” key.

- If a user name has not yet been set, just press the “Enter” key.

5 “Password:” is displayed. Input the password and press the “Enter” key.

- If a password has not yet been set, just press the “Enter” key.

6 Input “setup” and press the “Enter” key.

- SETUP MENU will be displayed.

▼SETUP MENU

```
-----SETUP MENU-----
[1]IP Address      [2]Subnet Mask    [3]Default Gateway
[4]User Name      [5]Password
[6]RS-232C Baud Rate [7]Projector Name [8]DHCP Client
[A]Advanced Setup [D]Disconnect All
[V]View All Setting [S]Save & Quit    [Q]Quit Unchanged

setup>
```

Note

- If the IP address has been changed, be sure to enter the new IP address in step 2.
- User name and password are not set in the factory default settings.
- If the user name or password is entered incorrectly three times in steps 4 or 5, SETUP MENU will be quit.

SETUP MENU (Main Menu)

▼ SETUP MENU

```

-----SETUP MENU-----
[1]IP Address      [2]Subnet Mask    [3]Default Gateway
[4]User Name      [5]Password
[6]RS-232C Baud Rate [7]Projector Name [8]DHCP Client
[A]Advanced Setup  [D]Disconnect All
[V]View All Setting [S]Save & Quit    [Q]Quit Unchanged

setup>
    
```

[1] IP Address

IP address settings. (Page 34)

[2] Subnet Mask

Subnet mask settings. (Page 34)

[3] Default Gateway

Default gateway settings. (Page 34)

[4] User Name (Factory default setting : Not Required)

Setting of user name for security protection. (Page 34)

[5] Password (Factory default setting : Not Required)

Setting of password for security protection. (Page 35)

[6] RS-232C Baud Rate (Factory default setting : 9600 bps)

Baud rate settings for the RS-232C terminals. (Page 35)

[7] Projector Name

It is possible to assign a projector name. (Page 35)

[8] DHCP Client

DHCP Client settings. (Page 35)

[A] Advanced Setup

Enters ADVANCED SETUP MENU. (Page 36)

[D] Disconnect All

Disconnect all connections. (Page 36)

[V] View All Setting

Displays all setting values. (Page 32)
Can also be used with ADVANCED SETUP MENU.

[S] Save & Quit

Save set values and quit menu. (Page 33)

[Q] Quit Unchanged

Quit menu without saving setting values. (Page 33)



Note

- The factory default settings for the projector are as follows:
DHCP Client : Off
IP address : 192.168.150.2
Subnet mask : 255.255.255.0
Default gateway : 0.0.0.0

ADVANCED SETUP MENU

▼ ADVANCED SETUP MENU

```

***** ADVANCED SETUP MENU *****
[1]Auto Logout Time [2]Data Port
[5]Network Ping Test
[6]Accept IP Addr(1) [7]Accept IP Addr(2) [8]Accept IP Addr(3)
[9]Accept All IP Addr [0]Search Port

[!]Restore Default Setting
[Q]Return to Main Menu

advanced>
    
```

[1] Auto Logout Time (Factory default setting : 5 minutes)

Setting of time until automatic disconnection of network connection. (Page 36)

[2] Data Port (Factory default setting : 10002)

Setting the TCP port number used when exchanging data. (Page 36)

[5] Network Ping Test

It is possible to confirm that a network connection between the projector and a computer etc. is working normally. (Page 37)

[6] Accept IP Addr(1)

[7] Accept IP Addr(2)

[8] Accept IP Addr(3)

[9] Accept All IP Addr (Factory default setting : Accept All)

For improved security, it is possible to set up to three IP addresses allowing connection to the projector. Set IP addresses can be cancelled using [9] Accept All IP Addr. (Page 37)

[0] Search Port (Factory default setting : 5006)

Setting the port number used when searching for the projector. (Page 38)

[!] Restore Default Setting

Restores all setting values that can be set using the menu to the default state. (Page 38)

[Q] Return to Main Menu

Return to the main SETUP MENU. (Page 38)

Setting up the Projector Using RS-232C or Telnet

Enter number or symbol of item to be selected on the **SETUP MENU**. When setting, input the details to be set. Setting is carried out one item at a time, and saved at the end.

View Setting Detail List ([V]View All Setting)

▼SETUP MENU

```

-----SETUP MENU-----
[1]IP Address      [2]Subnet Mask  [3]Default Gateway
[4]User Name      [5>Password      [6]RS-232C Baud Rate
[7]Projector Name [8]DHCP Client  [A]Advanced Setup
[V]View All Setting [S]Save & Quit  [D]Disconnect All
[Q]Quit Unchanged

setup>v
-----
Model Name       : XX-XXXX
Projector Name   : XX-XXXX
MAC Address      : XX:XX:XX:XX:XX:XX
DHCP Client      : Disabled
IP Address       : 192.168.150.2
Subnet Mask      : 255.255.255.0
Default Gateway  : Not Used
RS-232 Baud Rate : 9600 bps
Password         : Not Required
***** (Advanced Status) *****
Data Port        : 10002
Accept IP Address : Accept All
Auto Logout Time : 5 minutes
Search Port      : 5006
    
```

- ① Enter “v” and press the “Enter” key.
Display all setting values(*).

Set Items

Example: When setting IP Address (change from 192.168.150.2 to 192.168.150.3)

▼SETUP MENU

```

-----SETUP MENU-----
[1]IP Address      [2]Subnet Mask  [3]Default Gateway
[4]User Name      [5>Password      [6]RS-232C Baud Rate
[7]Projector Name [8]DHCP Client  [A]Advanced Setup
[V]View All Setting [S]Save & Quit  [D]Disconnect All
[Q]Quit Unchanged

setup>1
IP Address       : 192.168.150.2 *1
Please Enter     : 192.168.150.3 *2
(change)        -> 192.168.150.3 *2

-----SETUP MENU-----
[1]IP Address      [2]Subnet Mask  [3]Default Gateway
[4]User Name      [5>Password      [6]RS-232C Baud Rate
[7]Projector Name [8]DHCP Client  [A]Advanced Setup
[V]View All Setting [S]Save & Quit  [D]Disconnect All
[Q]Quit Unchanged

setup>v
-----
Model Name       : XX-XXXX
Projector Name   : XX-XXXX
MAC Address      : XX:XX:XX:XX:XX:XX
DHCP Client      : Disabled
IP Address       : 192.168.150.3 *3
Subnet Mask      : 255.255.255.0
Default Gateway  : Not Used
RS-232 Baud Rate : 9600 bps
Password         : Not Required
***** (Advanced Status) *****
Data Port        : 10002
Accept IP Address : Accept All
Auto Logout Time : 5 minutes
Search Port      : 5006
    
```

- ① Enter “1” (number of item to be set), and press the “Enter” key.
Display current IP address (*1).
- ② Enter IP address to be set and press the “Enter” key.
Display IP address after change (*2).
- ③ Enter “v” and press the “Enter” key to verify setting detail list.
IP address is being changed (*3).

Note

- Verification of setting detail list can be omitted.
- Setting details are not effective until they have been saved. (Page 33)
- If an invalid number is entered, an error message (“Parameter Error!”) will be displayed.

Save Settings and Quit ([S]Save & Quit)

Save set values and quit menu.

▼SETUP MENU

```
-----SETUP MENU-----
[1]IP Address      [2]Subnet Mask  [3]Default Gateway
[4]User Name      [5]Password
[6]RS-232C Baud Rate [7]Projector Name [8]DHCP Client
[A]Advanced Setup  [D]Disconnect All
[V]View All Setting [S]Save & Quit   [Q]Quit Unchanged

setup>s
All Connection will be disconnect.
Continue(y/n)? y
Apply New setting...Done.
```

①

②

- ① Enter “s” and press the “Enter” key.
- ② Enter “y” and press the “Enter” key.

Quit without Saving Settings ([Q]Quit Unchanged)

Quit menu without saving setting values.

▼SETUP MENU

```
-----SETUP MENU-----
[1]IP Address      [2]Subnet Mask  [3]Default Gateway
[4]User Name      [5]Password
[6]RS-232C Baud Rate [7]Projector Name [8]DHCP Client
[A]Advanced Setup  [D]Disconnect All
[V]View All Setting [S]Save & Quit   [Q]Quit Unchanged

setup>q
Quit Without Saving(y/n)? y
Setting Unchanged.
```

①

②

- ① Enter “q” and press the “Enter” key.
- ② Enter “y” and press the “Enter” key.

Setting up the Projector Using RS-232C or Telnet

The setting procedure for each item will be explained. For the basic procedure, please refer to “Set Items” on page 32.

IP Address Setting ([1]IP Address)

Setting of IP address.

setup>1		①
IP Address	:192.168.150.2	
Please Enter	:192.168.150.3	②
(change)	→ 192.168.150.3	*

- ① Enter “1” and press the “Enter” key.
- ② Enter numerical value to be set and press the “Enter” key.
Display IP address after change (*).

Subnet Mask Setting ([2]Subnet Mask)

Setting subnet mask.

setup>2		①
Subnet Mask	:255.255.255.0	
Please Enter	:255.0.0.0	②
(change)	→ 255.0.0.0	*

- ① Enter “2” and press the “Enter” key.
- ② Enter numerical value to be set and press the “Enter” key.
Display subnet mask after change (*).

Default Gateway Setting ([3]Default Gateway)

Setting default gateway.

setup>3		①
note: “0.0.0.0” means “Using no default gateway.”		
Gateway Address	:0.0.0.0	
Please Enter	:192.168.150.1	②
(change)	→ 192.168.150.1	*

- ① Enter “3” and press the “Enter” key.
- ② Enter numerical value to be set and press the “Enter” key.
Display gateway address after change (*).

Note

- If the values for IP Address, Subnet Mask or Gateway of the projector have been changed via Telnet, the computer cannot be connected to the projector depending on the computer’s network settings.

User Name Setting ([4]User Name)

Carrying out security protection using user name.

setup>4		①
User Name	:	
Please Enter	: XX-XXXX	②
(change)	→ XX-XXXX	*

- ① Enter “4” and press the “Enter” key.
- ② Enter user name and press the “Enter” key.
Display set user name (*).

Note

- User name can be up to 8 characters.
- You can input the characters below :
a-z, A-Z, 0-9, -, _
- In the default state, user name is not set.

Password Setting ([5]Password)

Carrying out security protection using password.

```

setup>5
Password      :
(Please Enter : sharppj)
(change)     -> sharppj
    
```

- ① Enter “5” and press the “Enter” key.
- ② Enter password and press the “Enter” key.
Display set password (*).

Note

- Password can be up to 8 characters.
- You can input the characters below :
a-z, A-Z, 0-9, -, _
- In the default state, the password is not set.

RS-232C Baud Rate Setting ([6]RS-232C Baud Rate)

Setting of baud rate for RS-232C terminals.

```

setup>6
0 ... 9600 bps
1 ... 38400 bps
2 ... 115200 bps
(Baud Rate Select[0-2]:2)
RS-232C Baud Rate : 115200 bps
    
```

- ① Enter “6” and press the “Enter” key.
- ② Select and enter the number 0, 1 or 2 and press the “Enter” key.
Display set baud rate (*).

Note

- Set the projector’s baud rate to the same rate as that used by the computer.

Projector Name Setting ([7]Projector Name)

It is possible to assign a projector name.

```

setup>7
Projector Name : XX-XXXX
(Please Enter  : MY XX-XXXX)
(change)     -> MY XX-XXXX
    
```

- ① Enter “7” and press the “Enter” key.
- ② Enter projector name.
Display set projector name (*).

Note

- Projector name can be up to 12 characters.
- You can input the characters below :
A-Z, 0-9, -, _ , (,) , space
(When “a-z” are input, they are converted to “A-Z” automatically.)
- It is the same as the name which can be confirmed or set, using RS-232C commands “PJN0”, “PJN1”, “PJN2” and “PJN3”.

DHCP Client Setting ([8]DHCP Client)

Setting DHCP Client to “Enable” or “Disable”.

Example: When setting DHCP Client to “Enable”

```

setup>8
note: It sets DHCP Client.
0 ... Disable
1 ... Enable
(DHCP Select[0-1]:1)
DHCP Client : Enabled

Success get data from DHCP server.
[MAC Address   ] : [XX:XX:XX:XX:XX:XX]
[IP Address    ] : [192.168.150.2]
[Subnet Mask   ] : [255.255.255.0]
[Default Gateway] : [0.0.0.0]
[DHCP IP Address] : [192.168.150.1]
    
```

- ① Enter “8” and press the “Enter” key.
- ② Enter “1” and press the “Enter” key.
Display the obtained values (*).

Setting up the Projector Using RS-232C or Telnet

Disconnecting All Connections ([D]Disconnect All)

It is possible to disconnect all the TCP/IP connections currently recognized by the projector. Even if the COM Redirect port is fixed in the Busy status due to a problem, it is possible to force the Ready status back by carrying out this disconnection.

```
setup>d
Disconnect All Connections(y/n)?y
Now Disconnecting...
```

- 1 Enter “d” and press the “Enter” key.
- 2 Enter “y” and press the “Enter” key.

Note

- If Disconnect All is performed, the connection to the projector via network will be forcibly disconnected.

Entering ADVANCED SETUP MENU

([A]Advanced Setup)

Enters ADVANCED SETUP MENU.

```
setup>a
***** ADVANCED SETUP MENU *****
[1]Auto Logout Time  [2]Data Port
[5]Network Ping Test
[6]Accept IP Addr(1) [7]Accept IP Addr(2) [8]Accept IP Addr(3)
[9]Accept All IP Addr [0]Search Port

[!]Restore Default Setting
[Q]Return to Main Menu

advanced>
```

- 1 Enter “a” and press the “Enter” key.

Setting Auto Logout Time (ADVANCED[1]Auto Logout Time)

If there is no input after a fixed time, the projector automatically disconnects network connection using the Auto Logout function. It is possible to set the time until the projector is automatically disconnected in units of a minute (from 1 to 65535 minutes).

```
advanced>1
Valid range      : 0 to 65535 (minute)
note: if you enter "0", auto logout function will be disable.
Auto Logout Time : 5
Please Enter      :15
(change)         -> 15
```

- 1 Enter “1” and press the “Enter” key.
- 2 Enter numerical value and press the “Enter” key.
Display set numerical value (*).

Note

- If the set value is made 0, the Auto Logout function is disabled.
- If an invalid number is entered, an error message (“Parameter Error!”) will be displayed and the screen returns to the ADVANCED SETUP MENU.

Data Port Setting

(ADVANCED[2]Data Port)

Setting of TCP port number. It is possible to set in the range of 1025 to 65535.

```
advanced>2
Valid range      :1025 to 65535
Data Port        :10002
Please Enter      :10005
(change)         -> 10005
```

- 1 Enter “2” and press the “Enter” key.
- 2 Enter numerical value and press the “Enter” key.
Display set numerical value (*).

Note

- Set according to need. Normally, use with the factory default setting.

Carrying out Network Ping Test (ADVANCED[5]Network Ping Test)

It is possible to confirm that a network connection between the projector and a computer etc. is working normally.

```

advanced>5
Ping dest IP addr :192.168.150.1
Please Enter :192.168.150.152
(change) --> 192.168.150.152
32 bytes from 192.168.150.152: icmp_seq = 1, time = 0 ms
32 bytes from 192.168.150.152: icmp_seq = 2, time = 0 ms
32 bytes from 192.168.150.152: icmp_seq = 3, time = 0 ms
32 bytes from 192.168.150.152: icmp_seq = 4, time = 0 ms
    
```

- ① Enter “5” and press the “Enter” key.
- ② Enter IP address of device to be tested and press the “Enter” key.
Display entered IP address (*1).
Display test result (*2).

Note

- If the “Enter” key is pressed without entering an IP address, the Ping destination IP address used previously is entered.
- If there is a fault with the connection, “Error: No answer” is displayed after a 5 second retry. In this case, please confirm the settings for the projector and the computer, and contact your network administrator.

Setting of Accept IP Address (ADVANCED[6]Accept IP Addr(1) - [8]Accept IP Addr(3))

It is possible to improve security of the projector by allowing connection from only a prescribed IP address. It is possible to set up to three IP addresses allowing connection to the projector.

```

advanced>6
Accept IP Addr(1) : 0.0.0.0
Please Enter : 192.168.150.152
(change) --> 192.168.150.152
    
```

- ① Enter “6”, “7” or “8” and press the “Enter” key.
- ② Enter numerical value and press the “Enter” key.
Display set numerical value (*).

Note

- To invalidate the Accept IP Address being currently set, enter “0.0.0.0”.
- If there is one or more Accept IP Addr being set, no connections are allowed from IP addresses that are not yet set. They can be cancelled using [9]Accept All IP Addr.

Accepting All IP Addresses (ADVANCED[9]Accept All IP Addr)

Removes IP addresses set with “Accept IP Addr”.

```

advanced>9
Accept All IP Addresses(y/n)? y
    
```

- ① Enter “9” and press the “Enter” key.
- ② Enter “y” and press the “Enter” key.

Note

- At the point in time where “y” was entered, the numerical values for Accept IP Addr(1)-(3) are reset to “0.0.0.0”.
- If “n” is entered, setting is not altered.

Setting up the Projector Using RS-232C or Telnet

Setting of Search Port (ADVANCED[0]Search Port)

Sets the port number used when searching for the projector from the network.

```
advanced>0
Please Enter Port Number for Search from Computer.
Valid range      : 1025 to 65535
Search Port      : 5006
Please Enter      : 5004
(change)         -> 5004 *
```

- ① Enter “0” and press the “Enter” key.
- ② Enter numerical value and press the “Enter” key.
Display set numerical value (*).

Note

- Set according to need. Normally, use with the factory default setting.

Return to Default Settings (ADVANCED[!]Restore Default Setting)

Returns all menu setting values to the default state.

```
advanced>!
Restore All Setting to Default(y/n)? y
— User Setting Initialized —
```

- ① Enter “!” and press the “Enter” key.
- ② Enter “y” and press the “Enter” key.

Note

- If the values for IP Address, Subnet Mask or Gateway of the projector have been returned to the default settings via Telnet, the computer cannot be connected to the projector depending on the computer's network settings.

Return to Main Menu (ADVANCED[q]Return to Main Menu)

Returns to the main SETUP MENU.

```
advanced>q
-----SETUP MENU-----
[1]IP Address      [2]Subnet Mask    [3]Default Gateway
[4]User Name       [5]Password
[6]RS-232C Baud Rate [7]Projector Name [8]DHCP Client
[A]Advanced Setup  [D]Disconnect All
[V]View All Setting [S]Save & Quit    [Q]Quit Unchanged
setup>
```

- ① Enter “q” and press the “Enter” key.
Returns to the SETUP MENU.

Resetting the Lamp Timer of the Projector via LAN

When the projector is connected to a network, you can use HyperTerminal or a similar communications program to send a command to reset the lamp timer. The example below uses Windows® XP as the operating system.

1 Click “Start” – “All Programs” – “Accessories” – “Communications” – “HyperTerminal”.

- If you do not have HyperTerminal installed, see the operation manual of your computer.
- Depending on the settings of your computer, you may be required to enter your area code and other details. Enter the information as required.

2 Enter a name in the “Name” field, and click “OK”.

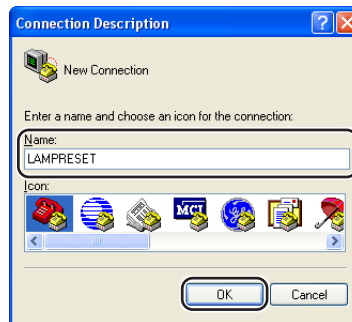

3 If you are required to enter the area code, enter it in the “Area code” field. From the “Connect using” drop-down menu, select “TCP/IP (Winsock)”, and click “OK”.



4 Enter the IP address of the projector in the “Host address” field (see “TCP/IP” on the “Network” menu of the projector), and enter the data port of the projector in the “Port number” field (“10002” is the factory default setting), and click “OK”.



Resetting the Lamp Timer of the Projector via LAN

5 Click “Properties” on the “File” menu.

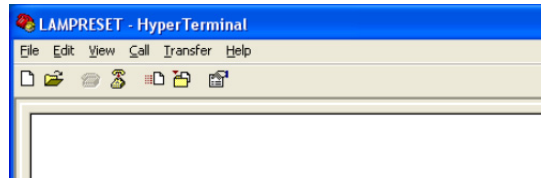

6 Click the “Settings” tab, and then click “ASCII Setup”.

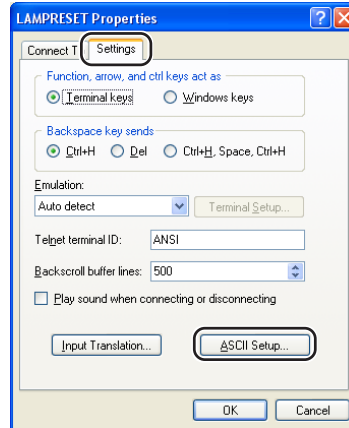

7 Select the check boxes next to “Send line ends with line feeds”, “Echo typed characters locally”, and “Append line feeds to incoming line ends”, and click “OK”.

- The LAMPRESET Properties window appears, click “OK”.

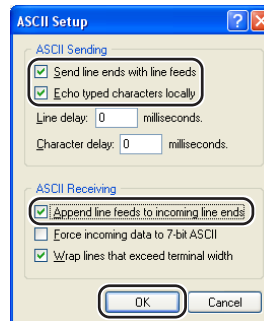

8 If a user name and/or password is set for the projector, enter the user name and password.

9 Send the lamp reset command “LPRE0001”.

- This command can only be sent when the projector is in standby mode.
- When “OK” is received, this indicates that the lamp was successfully reset.

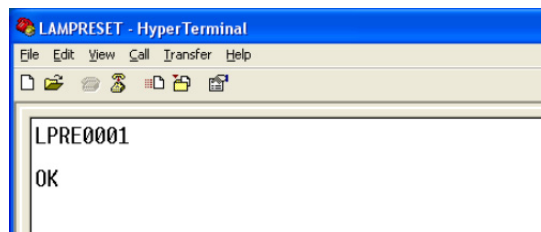

10 Close HyperTerminal.

Communication cannot be established with the projector

When connecting the projector using serial-connection

- ◀ Check that the RS-232C terminal of the projector and a computer or the commercially available controller are connected correctly.
- ◀ Check that the RS-232C cable is a cross-over cable.
- ◀ Check that the RS-232C port setting for the projector corresponds to the setting for the computer or the commercially available controller.

When connecting the projector to a computer using network (LAN)-connection

- ◀ Check that the cable's connector is firmly inserted in the LAN terminal of the projector.
- ◀ Check that the cable is firmly inserted into a LAN port for a computer or a network device such as a hub.
- ◀ Check that the LAN cable is a Category 5 cable.
- ◀ Check that the LAN cable is a cross-over cable when connecting the projector to a computer directly.
- ◀ Check that the LAN cable is a straight-through cable when connecting the projector with a network device such as a hub.
- ◀ Check that the power supply is turned on for the network device such as a hub between the projector and a computer.

Check the network settings for the computer and the projector

- ◀ Check the following network settings for the projector.
 - IP Address
Check that the IP address for the projector is not duplicated on the network.
 - Subnet Mask
When the gateway setting for the projector is "0.0.0.0" (Not Used), or the gateway setting for the projector and the default gateway setting for the computer are the same:
 - The subnet masks for the projector and the computer should be the same.
 - The IP address parts shown by the subnet mask for the projector and the computer should be the same.
(Example)
When the IP address is "192.168.150.2" and the subnet mask is "255.255.255.0" for the projector, the IP address for the computer should be "192.168.150.X" (X=3-254) and the subnet mask should be "255.255.255.0".
 - Gateway
When the gateway setting for the projector is "0.0.0.0" (Not Used), or the gateway setting for the projector and the default gateway setting for the computer are the same:
 - The subnets for the projector and the computer should be the same.
 - The IP address parts shown by the subnet mask for the projector and the computer should be the same.
(Example)
When the IP address is "192.168.150.2" and the subnet mask is "255.255.255.0" for the projector, the IP address for the computer should be "192.168.150.X" (X=3-254) and the subnet mask should be "255.255.255.0".

Note

- The factory default settings for the projector are as follows:
DHCP Client : Off
IP address : 192.168.150.2
Subnet mask : 255.255.255.0
Gateway address : 0.0.0.0 (Not Used)
- For network settings for the projector, refer to page [22](#).

Troubleshooting

- ◀ Take the following steps for checking the network settings for the computer.
 1. Open a command prompt (MS-DOS Prompt).
 - In the case of Windows® 98 or 98SE: click “START” → “Programs” → “MS-DOS Prompt” in order.
 - In the case of Windows® Me: click “START” → “Programs” → “Accessories” → “MS-DOS Prompt” in order.
 - In the case of Windows® 2000: click “START” → “Programs” → “Accessories” → “Command Prompt” in order.
 - In the case of Windows® XP: click “START” → “All Programs” → “Accessories” → “Command Prompt” in order.
 2. After launching the command prompt (MS-DOS Prompt), enter the command “ipconfig”, and press the “Enter” key.

Note

- Communication may not be established even after carrying out the network settings for the computer. In such cases, restart your computer.

C:\>ipconfig

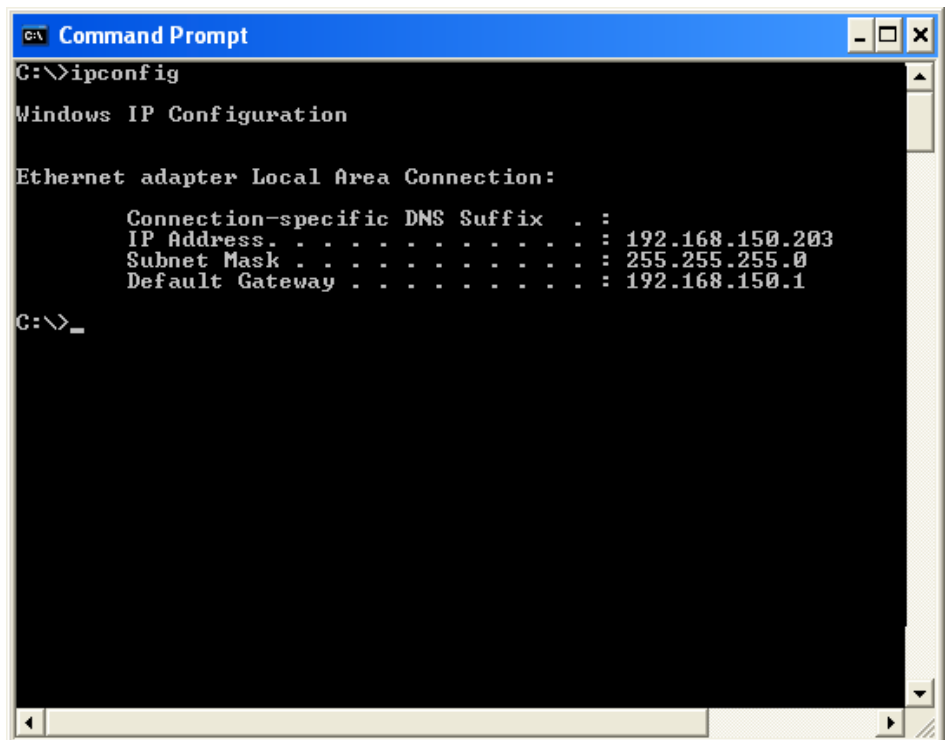

```
C:\>ipconfig

Windows IP Configuration

Ethernet adapter Local Area Connection:

    Connection-specific DNS Suffix  . : 
    IP Address. . . . .               : 192.168.150.203
    Subnet Mask . . . . .             : 255.255.255.0
    Default Gateway . . . . .         : 192.168.150.1

C:\>_
```

Note

- Usage examples of ipconfig
 - C:\>ipconfig /? displays how to use “ipconfig.exe”.
 - C:\>ipconfig displays the set IP address, subnet mask and default gateway.
 - C:\>ipconfig /all displays all the setting information related to TCP/IP.

3. To return to the Windows® screen, enter “exit” and press the “Enter” key.

- ◀ Check if the “TCP/IP” protocol is operating correctly using the “PING” command. Also, check if an IP address is set.
 1. Open a command prompt (MS-DOS Prompt).
 - In the case of Windows® 98 or 98SE: click “START” → “Programs” → “MS-DOS Prompt” in order.
 - In the case of Windows® Me: click “START” → “Programs” → “Accessories” → “MS-DOS Prompt” in order.
 - In the case of Windows® 2000: click “START” → “Programs” → “Accessories” → “Command Prompt” in order.
 - In the case of Windows® XP: click “START” → “All Programs” → “Accessories” → “Command Prompt” in order.
 2. After launching the command prompt (MS-DOS Prompt) enter a command “PING”.
Entry example C:\>Ping XXX.XXX.XXX.XXX
“XXX.XXX.XXX.XXX” should be entered with an IP address to be connected to, such as the projector.
 3. When connecting normally, the display will be as follows.
(The screen may be slightly different depending on the OS type).
<Example> when the IP address connected to is “192.168.150.2”

```

C:\> Ping 192.168.150.2

Pinging 192.168.150.2 with 32 bytes of data:
Reply from 192.168.150.2: bytes=32 time<1ms TTL=128
Reply from 192.168.150.2: bytes=32 time<1ms TTL=128
Reply from 192.168.150.2: bytes=32 time<1ms TTL=128

Ping statistics for 192.168.150.2:
    Packets: Sent = 4, Received = 4, Lost = 0 (0% loss),
    Approximate round trip times in milli-seconds:
        Minimum = 0ms, Maximum = 0ms, Average = 0ms

C:\>_
  
```

4. When a command cannot be sent, “Request time out” will be displayed.
Check the network setting again.
If communication can still not be established properly, contact your network administrator.
5. To return to the Windows® screen, enter “exit” and then press the “Enter” key.

A connection cannot be made because you have forgotten your user name or your password.

- ◀ Initialize the settings. (See page 54 of the projector’s operation manual.)
- ◀ After the initialization, carry out setting again.

Dimensions

Units: inches (mm)

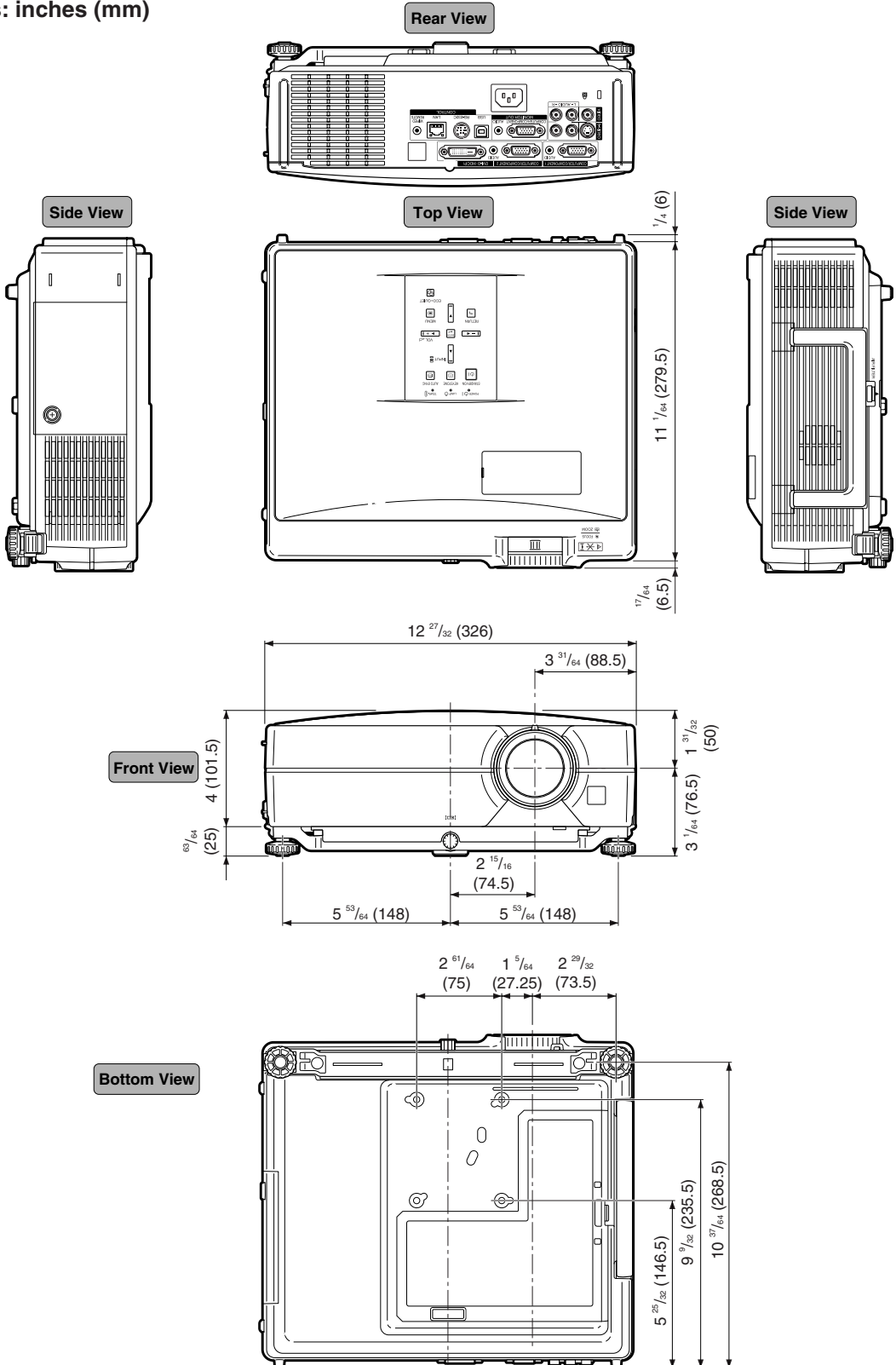

Projector and Lens Dimensions

[When AN-C12MZ is installed]

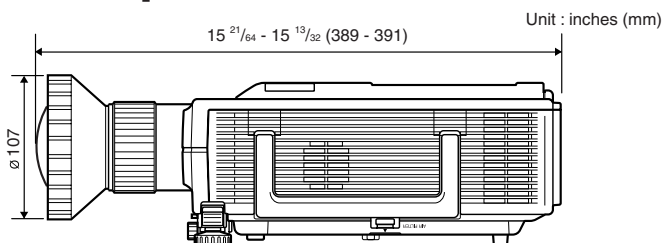

[When AN-C18MZ is installed]

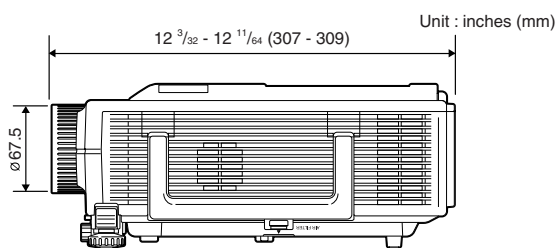

[When AN-C27MZ is installed]

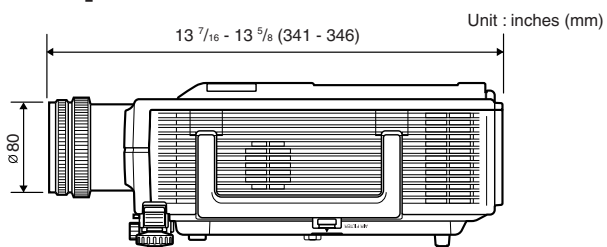

[When AN-C41MZ is installed]

